

# YUASA

## Technical Manual



# YUASA® BATTERY CHARGERS

## Yuasa SmartShot Automatic 12V 1.5 Amp 5 Stage Battery Charger



Part No. YUA1201501

Yuasa's Automatic 12V 1.5 Amp battery charger incorporates superior 5 stage charging technology. This high power unit provides error proof operation to fully charge sealed maintenance free and conventional lead acid batteries

- Provides up to 16 volts to enable recovery of sulfated batteries during pre-qualification stage
- 28 day Charge Recycle – re-evaluates battery status for long term storage
- Designed to prevent overcharging
- AC power LED indicator
- Charging and float mode LED display
- Reverse polarity protection
- Spark-free operation
- Battery accessory leads and fused ring connectors included
- Steel construction for durability
- 3 year limited warranty



## Yuasa SmartShot 900 Automatic 12V 900mA Battery Charger

Part No. YUA1200901

Yuasa's Automatic 900mA 12V battery charger is the industry's most powerful plug-in wall charger. Combining the latest technology and a host of user-friendly features, this compact, high-power unit provides optimum amperage return and is designed to fully charge and maintain conventional and sealed maintenance free batteries.

- Fully automatic three level charge cycle for effective charging
- Reaches 14.4 volts peak, then automatically switches to float
- Designed to prevent overcharging
- AC power LED indicator
- Charging and float mode LED display
- Reverse polarity protection
- Spark-free operation
- Durable construction for longer life
- Battery accessory leads and fused ring connectors included
- 12 ft. output cord
- 3 year limited warranty



**PREFACE:**

A Practical Understanding of Lead Acid Batteries. . . . . 2

**SECTION ONE: Battery Basics and Safety**

About this book . . . . . 3  
 About YUASA . . . . . 3  
 Features and Benefits. . . . . 4  
 The Lead Acid Battery . . . . . 5-6  
 The Yuasa Battery Line. . . . . 7  
 Yuasa’s Conventional Battery . . . . . 7  
 YuMicron Battery . . . . . 7  
 YuMicron CX Battery . . . . . 8  
 Sealed (MF) VRLA and High Performance Batteries . . . . . 8  
 Battery Safety . . . . . 9

**SECTION TWO: Selecting and Installing a New Battery**

Selecting the Proper Battery . . . . . 10  
 About Sensors . . . . . 11  
 Battery Activation for Conventional and YuMicron Types . . . . . 12  
 Activating Standard Batteries . . . . . 12

**SECTION THREE: Inspecting, Testing and Charging**

The Discharge – Charge Cycle . . . . . 13  
 Reasons for Self-discharge . . . . . 14-15  
 Ampere-Hour and Cold Cranking Amps . . . . . 16  
 Inspecting a Battery . . . . . 16-17  
 Battery Testing Devices. . . . . 17  
 Battery Testing. . . . . 18  
 Chargers and Charging . . . . . 19-20  
 Charging a New Standard Battery . . . . . 20-21  
 Quick Charges . . . . . 21

**SECTION FOUR: Maintenance and Storage**

Monthly Maintenance for Conventional and YuMicron Types . . . . . 22  
 Storage . . . . . 22  
 Sulfation and Freezing . . . . . 22-23

**SECTION FIVE: Sealed VRLA Batteries**

New Generation Battery Technology. . . . . 24  
 Sealed VRLA Battery Construction . . . . . 24  
 Features . . . . . 24-25  
 How a Sealed VRLA Battery Differs from Conventional Types . . . . . 25  
 Activation and Installation . . . . . 26  
 To Activate a Sealed VRLA Battery. . . . . 26-27  
 Measuring Voltage . . . . . 28  
 Discharge Characteristics. . . . . 29  
 Self-discharge. . . . . 30  
 Choosing a Charger . . . . . 30  
 Charging a Newly Activated Sealed VRLA Battery. . . . . 31  
 Routine Charging . . . . . 32  
 Charging Instructions for Sealed VRLA Batteries with Voltage of 11.5 or Less . . . . . 33  
 Routine Maintenance for Sealed VRLA Batteries. . . . . 33

**GLOSSARY**

. . . . . 34-40



# A Practical Understanding of Lead Acid Batteries

Lead acid batteries are relatively simple in design. Dissimilar metal plates are immersed in an electrolyte solution consisting of sulfuric acid and water. These are then insulated from each other with a permeable, non-conductive material, which allows the transfer of ions. The transfer of ions occurs during the discharge and recharge of the battery. Also occurring is the change in specific gravity or density of the electrolyte. During the discharge period, sulfuric acid is drawn from the electrolyte into the pores of the plates. This reduces the specific gravity of the electrolyte and increases the concentration of water. During the recharge, this action is reversed and the sulfuric acid is driven from the plates, back into the electrolyte, increasing the specific gravity.

During the discharge, lead sulfate is being formed on the battery plates. Although this is the normal activity within the battery during discharge, a timely recharge is required to drive out the sulfuric acid into the electrolyte. Without this recharge, the lead sulfate will continue to develop and become difficult if not impossible to breakdown during recharge. Once this advanced sulfation develops, permanent capacity loss or total failure of the battery is likely. Besides the sulfation concerns, many other detrimental actions are taking place inside the battery while in a discharged condition.

The corrosive effect on the lead plates and connections within the battery is greatly increased due to the reduced specific gravity of the electrolyte. The corrosion of the plates will typically result in a gradual reduction in performance followed by battery failure. The corrosion associated with the inter cell connectors and the connecting welds will in many instances result in a sudden battery failure. The corroded connector may have sufficient integrity to support low drain accessories such as lights and instruments, but lack the necessary strength to provide the high discharge current required to start the vehicle. This corrosive effect can also dissolve the lead into solution, which in turn may compromise the plate insulators and result in micro shorts. Another condition that frequently occurs in a discharged battery is freezing. In a deeply discharged battery, the electrolyte has a

reduced specific gravity and becomes a higher percentage of water than sulfuric acid. During this condition, the battery may freeze at temperatures as high as 32°F. The electrolyte in a fully charged battery will not freeze in temperatures down to -65°F.

Deep discharge can be created by a multitude of conditions, but the predominant reason is neglect. During long periods of storage, the battery state of charge must be checked and maintained per the battery manufacturers recommendations. Other conditions that can drain the battery are inoperative or inadequate charging systems on vehicles, parasitic or key off drains, loose or dirty terminal connections, etc. Although many of these conditions can be corrected, often the problems you cannot correct may be overcome by a periodic charging schedule. You can establish a routine by which you check and charge your battery or choose to permanently attach a Yuasa Automatic Charger while the vehicle is not in use.

When charging your battery, always refer to the instructions on both the battery and the charger. While maintaining your battery at a full state of charge will insure optimum life, overcharging may significantly reduce it. With a conventional type battery that offers access to the cell compartments, the periodic addition of distilled water may be required. Water loss is normal in these batteries through the process of electrolysis and evaporation. Low electrolyte levels that expose the lead plates to the air will result in permanent damage to the battery. Maintain the electrolyte levels above the minimum fill lines on the battery and at or below the maximum line. A sealed VRLA (Valve Regulated Lead Acid) battery should be maintained with the same care as a conventional type battery with the exception of the addition of distilled water. Sealed VRLA batteries have a predetermined quantity of electrolyte added at the factory or in the field using the acid bottle specified for the battery. Once activated, the battery is permanently sealed and must never be opened.

A little bit of care and understanding of how your battery operates and is maintained will insure maximum service life.

# Battery Basics and Safety

## About this book

If you're looking for more than everyday information about batteries, read on.

Maybe you're a retailer, the expert whose battery knowledge and recommendations guide customers every day. Perhaps you are a service technician or dealer – the person vehicle owners turn to with questions. Or maybe you're an enthusiast set on “knowing everything” about your bike and how to keep it running.

Whatever your reason for wanting to boost your battery IQ, YUASA is pleased to provide this copy of the ultimate battery book.

It's filled with in-depth information: how batteries work, maintenance and installation tips and how to get maximum power and life from your battery. We'll talk about chargers and testers. Of course, we'll also fill you in on the complete line of YUASA batteries, chargers and accessories.

## About YUASA

The first thing you need to know about batteries is YUASA. You might say that when it comes to powersports vehicle batteries, we wrote the book! We're the largest manufacturer and distributor of small engine starting batteries in North America.

If you purchased a motorcycle, snowmobile, personal watercraft, ATV, riding mower or garden tractor manufactured in the U.S., chances are the battery that starts it was made by Yuasa. In fact, our batteries are original equipment in just about every major make of powersports vehicles.

If you've bought a replacement battery for your powersports vehicle, most likely it was made by Yuasa. Altogether, we manufacture approximately three million batteries a year for small engine starting applications at our Reading, Pennsylvania plant.

## Features and Benefits

Component	Features	Benefits
Cast Grid	Special Grid Design	Severe vibration resistance & improved conductivity
Active Material	Proprietary Formulation	Reduced shedding, maximum utilization, & long service life
Pasted Plates	Specified Thickness & Weight	Ensures vibration resistance through precise compression & proper service life through specified active material balance
Dried-Charged Plates	Tank Formed & Dried Plates	Properly dried plates in a sealed battery have a virtually limitless shelf-life, while still retaining 70-80% state of charge when filled with acid
Top Lead Connections	Through-Partition-Construction, Large Straps	Shorter current path for increased electrical conductivity & higher starting currents, heavier parts for maximum durability
Case-Cover Seal	Thermal Bonded Plastic	Air tight seal to prevent air ingress & acid seepage
Terminal-Cover Seal	Patented Poly-Seal Terminal	Eliminates acid seepage, reduces corrosion, & extends battery life
Case & Cover	Polypropylene	Superior resistance to gasoline & oil, impact resistant in extreme weather conditions
Additive	Sulfate Stop (Some models)	Sulfate stop added to reduce the solubility of lead into the acid, which then reduces battery sulfation potential
<b>YuMicron</b>		
Separator	Leaf Separator	Polyethylene leaf with glass mat sheet bonded for compression to withstand severe vibration conditions
<b>YTX</b>		
Separator	Absorbed Glass Mat	Absorbs acid while creating cell compression for extreme vibration resistance
Top Lead Alloy	Calcium Alloy	Increased weld strength & severe vibration resistance
Vent System	Valve & Flame Arrestor	Valve relieves excess pressure to prevent bursting, flame arrestor frit prevents internal combustion
<b>High Performance Maintenance Free</b>		
Grid System	Computer-Designed Radial Grids	Increased conductivity for higher starting wattage, increased vibration resistance
Separator	Puncture Resistant AGM Material	High puncture resistant separator for increased service in high vibration applications

## The Lead Acid Battery

**Let's look first at battery basics: what a battery is and how it works.**

Lead acid batteries are used as a power source for vehicles that demand a constant and uninterrupted source of energy. Just about every vehicle today does. For example, street motorcycles need lights that operate when the engine isn't running. They get it from the battery. Accessories such as clocks and alarms are battery-driven.

Starting your vehicle depends on a battery.

Technically speaking, the battery is an electrochemical device that converts chemical energy to electrical energy. The first thing you notice inside a battery is the cells. Each cell has about two volts (actually, 2.12 to 2.2 volts, measured on a DC scale). A 6-volt battery will have three cells. A 12-volt battery, six cells.

### Standard Features

#### HEAT SEALED CASE TO COVER

protects against seepage and corrosion – bonded unit gives extra strength.

#### THRU-PARTITION CONSTRUCTION

provides shorter current path with less resistance than “over the partition” construction – you get more cranking power when you need it!

#### PATENTED SEALED POST

prevents acid seepage, reduces corrosion – extends battery life.

#### SPECIAL ACTIVE MATERIAL

is compounded to withstand vibration, prolong battery life and dependability.

#### POLYPROPYLENE COVER AND CONTAINER

gives greater resistance to gas and oil – and impact in extreme weather conditions!

#### SPECIAL GRID DESIGN

withstands severe vibration, assures maximum conductivity.

#### SPECIAL SEPARATOR

provides high cranking power.

#### HEAVY DUTY GLASS MAT

resists shedding of active material even under severe vibration.

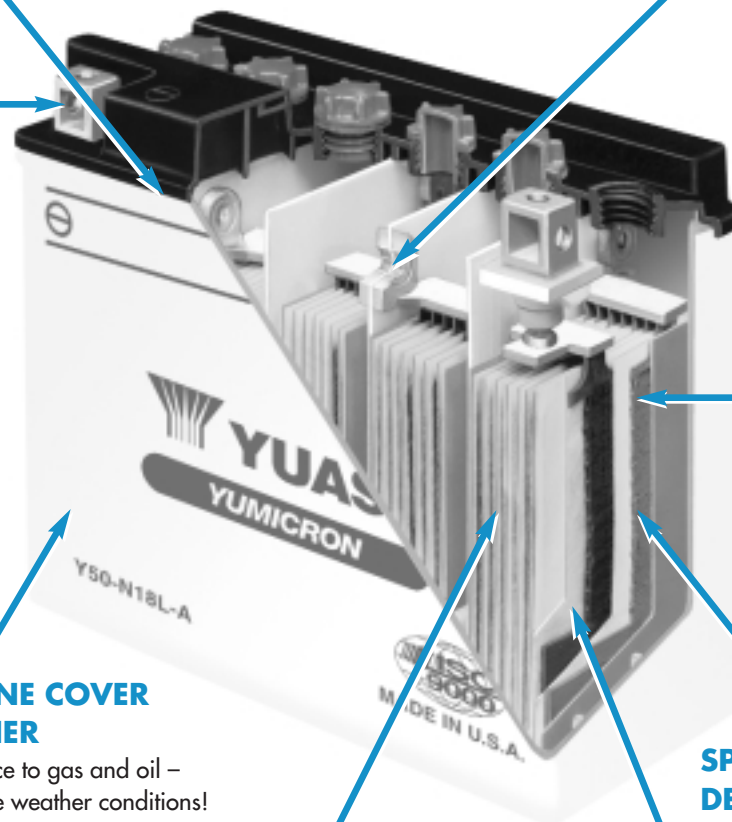

## Battery Basics and Safety

The cells consist of lead plates that are positive and negative charged. Inside the cell they're stacked alternately – negative, positive, negative. Insulators or separators – usually fiberglass or treated paper – are placed between the plates to prevent contact. Cranking current increases as the plate surface area in the battery increases – the more plates in a cell, or the larger the plates, the greater the current capacity (or flow of electricity). Typically, capacity increases as the amount of active material increases in the battery.

The alternate plates in each cell are connected at the top into two groups, one positive and one negative. Each cell's groups of plates are then connected in series – positive to negative – to those in the next cell.

Basically, that's the internal hardware. Next, a solution of sulfuric acid and distilled water – the electrolyte – is added. And the action starts. A reaction between the lead plates and the electrolyte sets off a chemical change. This in turn creates the electrical charge in a battery.

That's the process, in a nutshell, that makes every battery work. So, are all batteries the same?

Obviously not. Actually, there can be a number of differences, and they go far beyond things like box size or terminal location. That's true for different brands, as well as for different lines produced by the same manufacturer. Take two types of YUASA batteries, for example: our Conventional and YuMicron batteries.

What's different? First there's cranking power: YuMicron has more because YuMicron batteries boost plate surface area with thin, high-tech separators that make room for two extra plates in each cell. YuMicron also has a special intercell connector that minimizes resistance to further maximize power. It has a special glass mat that resists vibration damage.

Just for the record, let's state how the Conventional and YuMicron batteries aren't different: they're both lead-antimony batteries, for openers (other batteries in YUASA's line, including the YuMicron CX, use lead-calcium technology). They have certain things in common that we think should be part of every battery: like sealed posts to resist corrosion, tough polypropylene covers and containers, and heat sealed construction for a strong, bonded unit. And both share certain design features, like special separators and through-partition construction.

Now, does all this mean YuMicron is automatically a better choice than the conventional battery? Of course not. It all depends on what you need to do. Some of the YuMicron features might not be a big deal to a lawn tractor owner, but a feature like our unique cover design that minimizes electrolyte spillage is going to be really important to the guy on a watersport vehicle or ATV.

Each YUASA line of batteries has its unique features that account for differences in price and differences in performance – and that's what makes it the right battery for a particular vehicle. Buy what you need. Don't pay for what you don't need.

### POINTS TO REMEMBER

- ❑ **A battery converts chemical energy to electrical energy.**
- ❑ **Each cell has approximately 2 volts: 3 cells for a 6-volt battery, 6 cells for a 12-volt battery.**
- ❑ **Inside each cell are electrically charged positive and negative lead plates, isolated from each other by separators.**
- ❑ **Chemical action between plates and electrolyte creates an electrical charge.**
- ❑ **Current is the flow of electricity.**



## The YUASA battery line...

The right battery for the right job – that's where it all starts. YUASA's comprehensive line has the right small engine starting battery... whatever the vehicle, however tough the application.

## YUASA's Conventional Battery



The industry standard for motorcycles, snowmobiles and riding mowers, our Conventional Battery is anything but conventional. This workhorse is engineered to protect against seepage and corrosion... withstand vibration... and deliver high cranking power, even when the weather's dealing its worst. It's the rugged, reliable and dependable battery that customers are looking for!

These features are built into our conventional manifold vented battery... and every battery in the YUASA line:

- **Patented separators** provide high cranking power
- **Through-partition construction** delivers maximum power
- **Unique sealed posts** resist corrosion – for longer battery life
- **Polypropylene cover and container** resist damage from gas, oil, impact
- **Heat-sealed, bonded unit construction** protects against seepage and corrosion

## YuMicron



Personal watercraft, snowmobiles and ATVs make special demands – and YUASA's YuMicron Battery meets them head-on. The high-tech, power-boosting design also makes YuMicron ideal for accessory-laden touring bikes and modified machines.

- **Heavy duty glass mat** resists vibration damage
- **Special thin YuMicron Separator** packs in extra plates, delivers up to 30% more cranking power than conventional types
- **Through-the-wall intercell connector** minimizes internal resistance, maximizes power
- **Sulfate Stop** curbs plate sulfation – and provides longer life

## Battery Basics and Safety

### YuMicron CX



For top power, less maintenance and longer life, YuMicron CX is the battery of choice. The first motorcycle battery built on lead-calcium technology, YuMicron CX is specially designed for today's big, complex machines, where higher cranking power is a must. It delivers all the features of the standard YuMicron – plus...

- **Unique CX design** for higher cold cranking amps
- **Lead-calcium technology** reduces water loss – and servicing – by 66% compared to lead antimony
- **And, CX substantially reduces self-discharge** – for longer time between charges

### Sealed (MF) VRLA and High Performance



Sealed (MF) VRLA (Valve Regulated Lead Acid) means a battery that's perfect for people who have better things to do than battery maintenance! Our permanently sealed VRLA battery never needs refilling; however, it still needs periodic charging. Ideal for motorcycles, scooters, ATVs, riding mowers and personal watercraft.

- **Spill-proof design** means virtually no possibility of leaks
- **Advanced lead-calcium technology** pumps up starting power
- **Sulfation retardant** dramatically reduces battery-killing plate sulfation
- **And, sealed VRLA batteries hold voltage** longer and need less charging in standby or storage mode
- **High Performance version** provides greater cranking power with 12 extra plates per battery

## Battery Safety

As with anything, with batteries you have to know what you're doing. Batteries can be dangerous. But they don't have to be if some simple safety precautions are followed.

Basically, working with batteries poses two hazards: potentially explosive gases that are given off during charging, and sulfuric acid, which is very corrosive.

**Here's an 8-point list that'll help keep those hazards under control:**

1. **ABSOLUTELY NO SMOKING, SPARKS OR OPEN FLAMES AROUND BATTERIES.** Batteries can produce hydrogen and oxygen; if they ignite the battery can rupture.
2. On conventional batteries, loosen vent caps when charging and ventilate the entire charging area. A build-up of hydrogen and oxygen levels in the battery – or in the room where it's being charged – can create a hazard.
3. If a battery feels hot to the touch during charging, stop charging and allow it to cool before resuming. Heat damages the plates, and a battery that's too hot can rupture.
4. **Never put the red sealing cap back on the battery once you take it off. If you do, gases trapped inside can explode. Make sure the vent tube isn't kinked or blocked, for the same reason.**

5. Properly connect charger to battery: positive to positive, negative to negative. Unplug the charger or turn it off before you disconnect the leads; that cuts down on the chance of sparks.

6. Always wear eye protection, protective gloves and protective clothing.

7. Clean up acid spills immediately, using a water and baking soda solution to neutralize (1 lb. baking soda in 1 gal. water).

8. Make sure acid container is clearly marked and the work area is well lighted.

**If sulfuric acid is swallowed or splashed in the eyes, take immediate action.** While the diluted sulfuric acid used as electrolyte can burn the skin, this type of injury is generally less serious. Sulfuric acid in the eyes can cause blindness. Serious internal injuries or death can result from ingesting sulfuric acid.

### Antidotes:

**External** – flush with water.

**Internal** – drink large quantities of milk or water, followed by milk of magnesia, vegetable oil or beaten eggs. Call a poison control center or doctor immediately.

**Eyes** – flush for several minutes with water, get immediate medical attention.

### POINTS TO REMEMBER

- Ventilate battery charging area.**
- Charging gives off gases – no smoking, sparks or flames.**
- Safety glasses or face shields protect against eye damage.**
- Acid swallowed or in the eyes requires immediate antidotes and medical care.**
- All safety considerations are important... review them frequently.**

# SECTION 2

## Selecting and Installing a New Battery

### Selecting the Proper Battery

Selecting the right battery is an important decision. You'd be amazed how often the "problem" with a battery is that it's the wrong one for the application.

To make doubly sure you're on track, you'll need one of two things – either the latest YUASA Battery Specifications and Applications book, or the original equipment (OE) microfiche. Of course, you can always go to the old battery you're replacing. The trick, though, is to make sure it's the original. Otherwise, you may be simply repeating the same problem that caused the battery to need replacing.

OK, let's say you're replacing the battery on an '81 Kawasaki – a KZ1000-C Police, 1000cc.

Referring to the YUASA Battery Specifications and Applications book, you first look under the Kawasaki listing. Then find the right engine size – 1000cc, where you find the KZ1000-C Police. You're looking for an '81, so the place to be is '80 to '81. The chart on this page shows what it looks like.

If this were a sensor-equipped battery – which it isn't – the applications book would mark it with a footnote (†). That tells you to order it with a sensor.

What's the right battery? You'll see there are three of them: a High Performance Maintenance Free YTX20HL-BS, a Maintenance Free VRLA YTX20L-BS, and a YuMicron YB16L-B battery. Any of these will do fine. If your machine has increased compression modifications to the engine, for example, you might want the additional

cranking power. And if the added benefit of never adding water again appeals to you, go with the High Performance Maintenance Free or the Maintenance Free VRLA style batteries.

A few words of advice: always double-check that you have the right battery for your application before you charge and install it. If you have any questions, check out our website at [www.yuasabatteries.com](http://www.yuasabatteries.com) or contact us toll free at **1-866-431-4784**.

**Warning: In the event you want to upgrade to a sealed VRLA battery, please ensure you have the proper charging voltage. Always refer to your service manual.**

		MOTORCYCLE				
cc	Model	Year	High Performance Maintenance Free	Maintenance Free VRLA	YuMicron	Conventional
<b>KAWASAKI</b>						
1000	KZ1000-P Police	'02-'03	YTX20HL-BS	YTX20L-BS	-	-
	KZ1000-P Police	'82-'01	YTX20HL-BS *	YTX20L-BS *	YB18L-A	-
	KZ1000-C Police	'80-'81	YTX20HL-BS *	YTX20L-BS *	YB16L-B	-
	KZ1000-C Police, Z1-R	'78-'79	YTX14AHL-BS	-	YB14L-A2	-
	KZ1000, LTD	'77-'80	YTX14AHL-BS	-	YB14L-A2	-
	KZ1000-E ST, Shaft	'79-'80	YTX20HL-BS *	YTX20L-BS *	YB16L-B	-
	KZ1000-G Classic	'80	YTX14AHL-BS	-	YB14L-A2	-
	KZ1000, LTD, CSR	'81-'83	YTX20HL-BS *	YTX20L-BS *	YB18L-A	-
	KZ1000-R Replica	'82-'83	YTX20HL-BS *	YTX20L-BS *	YB18L-A	-
	Z1000	'03-'04	-	YTX9-BS	-	-

### POINTS TO REMEMBER

- ❑ Check current Applications Book or microfiche for right replacement battery.
- ❑ There may be two or more "right" batteries – choose by performance needs.
- ❑ Double check numbers before activation and installation.

## Selecting and Installing a New Battery

### About Sensors

Many of today's motorcycles use batteries equipped with sensors. They're either built in the battery, or packed with it.

A sensor is a "low fuel" warning light. It tells you when you're getting low – in this case, on electrolyte. The sensor causes a warning light to flash, signaling that it's time to add water to the battery. The cutaway views below show what a sensor looks like.

Sensors are sort of particular: they don't go with just any battery. Which means it's important to replace the old battery and sensor with the correct YUASA sensor battery listed in the applications book. So, sensor rule

one is this: replace both battery and sensor at the same time.

"But the sensor's original equipment," you say. Doesn't matter. Being OE doesn't mean it's OK in another manufacturer's battery. In fact, OE sensor plugs vary considerably in length, size and diameter. A plug that's too long can short out a battery and mess up the electrical system. If the plug's short, the warning light will flash way too early.

Note, too, that even YUASA's sensor batteries are not interchangeable; they have different vent locations, sensor wire lengths and diameter of cylinder connectors.

### CUT-AWAY VIEW OF SENSOR

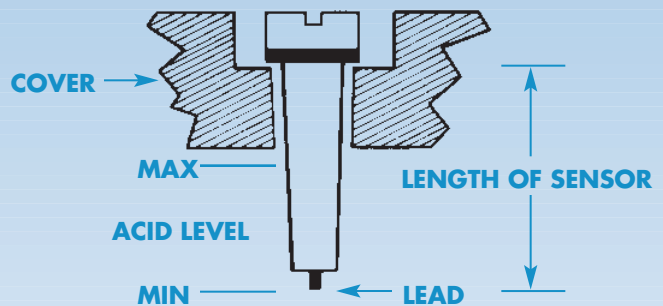
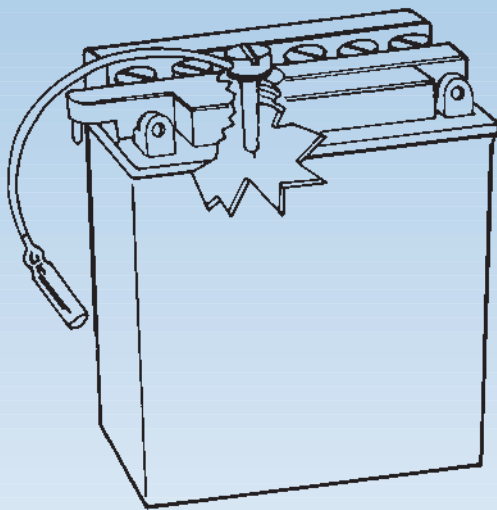

### POINTS TO REMEMBER

- Replace battery and sensor at same time.
- Original equipment sensor isn't "OK" for a new battery.
- Sensor batteries and sensors are not interchangeable – check Applications Book.



**SECTION**  
**2**

## Selecting and Installing a New Battery

### Battery Activation for Conventional and YuMicron Types

Sealed at the factory, a new YUASA battery has an indefinite shelf life as long as it remains sealed, with the red cap in place, and is stored at room temperature. Once it's unsealed, a battery should be activated, charged and installed. The plates of an unsealed, uncharged battery begin to oxidize. That makes it more difficult to charge later. (We talk more about sulfation later in this book.) And if it's charged and sits around, it starts to discharge and sulfate; how fast depends on temperature.

Here are the steps for activating most batteries, including YUASA's Conventional, YuMicron, YuMicron CX. (Sealed VRLA – YT or YI – batteries are activated differently, see page 26.)

#### Activating Standard Batteries

**1. Right before adding electrolyte, remove filling plugs.** Also remove the sealing tube – the red cap – and throw it away. (Putting this cap back on after the battery's filled with acid can cause an explosion.)

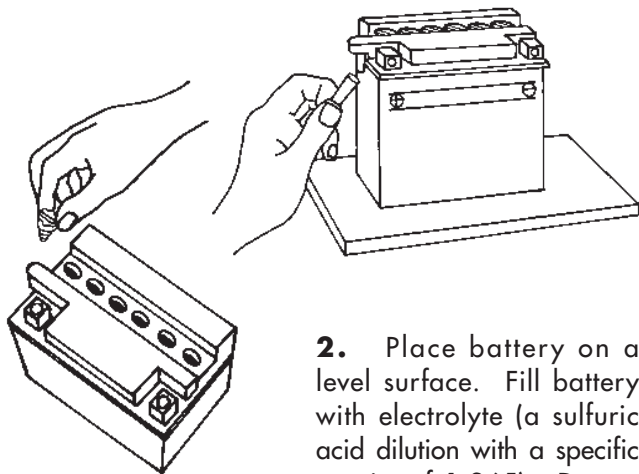

**2.** Place battery on a level surface. Fill battery with electrolyte (a sulfuric acid dilution with a specific gravity of 1.265). Do not use water or any other liquid to activate.

Electrolyte should be between 60°F and 86°F before filling. Fill to UPPER LEVEL as indicated on battery.

**NOTE:** **Never** activate a battery on the vehicle. Electrolyte spillage can cause damage.

**3. Let battery stand for at least 30 minutes.** Move or gently tap the battery so that any air bubbles between the plates will be expelled. If acid level has fallen, refill with acid to upper level.

**4.** A battery must be completely charged before installation. Charge for three to five hours at the current equivalent of 1/10 of its rated capacity found in the Yuasa Applications Book.

#### YUMICRON Battery Specifications

BATTERY TYPE	CAPACITY AH (10H-R)	DIMENSIONS – INCHES (± 1/16 IN)		
		L	W	H
YB2.5L-C	2.5	3 3/16	2 3/4	4 1/8
YB2.5L-C-1	2.5	3 3/16	2 3/4	4 1/8
YB3L-A	3	3 7/8	2 1/4	4 3/8
YB3L-B	3	3 7/8	2 1/4	4 3/8
YB4L-A	4	4 3/4	2 3/4	3 5/8
YB4L-B	4	4 3/4	2 3/4	3 5/8
YB5L-B	5	4 3/4	2 3/8	5 1/8

Rated Capacity →

**5.** During charging, batteries can spit electrolyte out the open vent. Take care to loosely refit vent caps.

**6.** Check during initial charging to see if electrolyte level has fallen, and if so, fill with acid to the UPPER LEVEL. After adding, charge for another hour at same rate as above to mix water and acid. Note: this is the last time electrolyte should be added, but distilled water should be added as required.

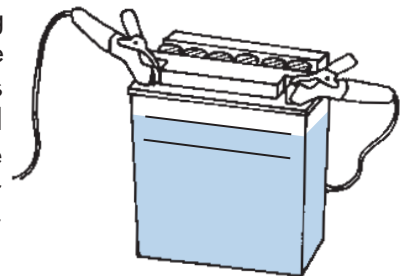

**7. When charging's done, replace plugs firmly. Do not apply excessive pressure. Finger tighten only. Do not over-tighten.**

**8.** Wash off spilled acid with water and baking soda solution, paying particular attention that any acid is washed off the terminals. Dry the battery case.

# Inspecting, Testing and Charging

## The Discharge - Charge Cycle

As we mentioned earlier, an electrochemical action within the battery produces electricity. To understand it, let's look inside a battery again: you'll see cells made up of lead plates. Some plates are positive charged. Others are negative charged. There's also the electrolyte – a sulfuric acid solution that conducts the current. It sets off the chemical process that takes place in the battery.

So what goes on when a battery discharges?

The electrolyte reacts chemically with the lead plates – and it's not exactly a match made in heaven: it turns them into lead sulfate. If sulfate reminds you of sulfation, you're right on target: this build-up of sulfate crystals is exactly what battery-killing sulfation is.

In the process, the electrolyte – which contains hydrogen, sulfur and oxygen – gives up its sulfur and some of its oxygen. The electrolyte turns to water. Now you know why a discharged battery – filled with water instead of electrolyte – can turn into an ice block when the temperature drops even into the 20s. On the other hand, a properly-charged battery won't freeze until the mercury gets way down in the minus range.

The chemical process causes free electrons to slowly gather on the negative plates. They just hang there until a load is placed on the battery – a light or starter's switched on – which causes a swarm of electrons to rush to the positive plates.

If the chemical process just went on and on, unchecked, the lead plates would soon turn totally to lead sulfate, the electrolyte would become pure water,

and the chemical and electrical activity inside the battery would come to a standstill. It's bad for a battery. So is allowing a battery to remain discharged for a prolonged period. Recharging becomes hard or impossible.

The good news: except in extreme cases, the process of discharging can be reversed. You work that magic by putting a larger voltage on the battery – for example, 14v on a 12v battery. That's charging.

Here's what goes on when a battery charges:

The electrical charge flowing back in causes the lead sulfates to send their sulfate back into the electrolyte. As a result, both the electrolyte and the plates return to their original composition.

You'll notice bubbles in an actively-charging battery. That's called gassing. It occurs because hydrogen and oxygen gases are liberated as the charging current breaks down the water.

Several things are actually happening here. The process breaks down water into hydrogen and oxygen vapor, which escapes out the vent tube. You have to replace that loss. Add distilled water to each cell after charging. Then give the battery a "mixing charge" for another hour. The hydrogen and oxygen gases that are given off can also build up pressure in the battery – which is why batteries are vented, and why the vent tubes can't be bent or blocked. Very importantly, hydrogen and oxygen are very explosive. It bears repeating that sparks, flames and cigarettes around charging batteries can be a one-way ticket to trouble.

### POINTS TO REMEMBER

- ❑ **Deep discharge or prolonged discharge leads to harmful sulfation.**
- ❑ **A discharged battery freezes much faster than a charged battery.**
- ❑ **Charging can reverse discharging.**
- ❑ **Charging gives off hydrogen and oxygen, which are explosive.**

# SECTION 3

## Inspecting, Testing and Charging

### Reasons for Self-discharge

Batteries have a natural tendency to discharge. There are a number of reasons why: self-discharge, high temperatures, drain from electrical accessories on a vehicle, and short trips that aren't enough to recharge the battery.

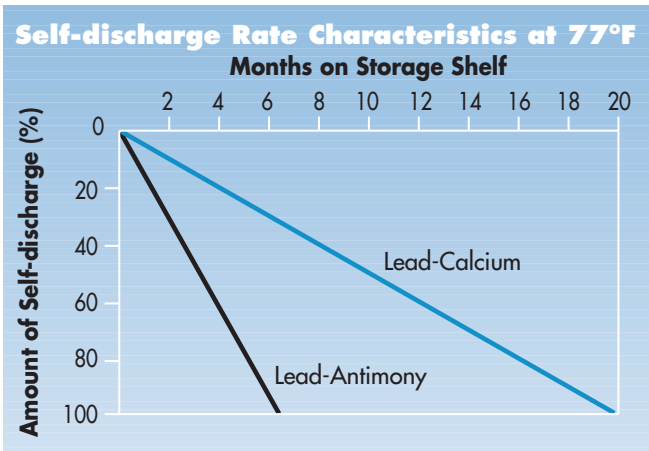

**Self-Discharge:** Self-discharge goes on all the time. It's a battery fact of life that they get weaker from "just sitting." How rapidly batteries self-discharge depends, first of all, on battery type. Lead-calcium batteries, such as YUASA's CX, YT, YI, discharge more slowly than conventional batteries. At room temperature lead-calcium discharges at 1/300 volt per day. Conventional lead-antimony batteries discharge at 1/100 volt per day.

**Temperature:** Outside temperature plays a big part, too. As the mercury goes up, batteries discharge faster. Particularly in hot climates, that can mean trouble: every 18°F doubles the discharge rate, so a battery at 95°F discharges twice as fast as one at 77°F. And temperatures

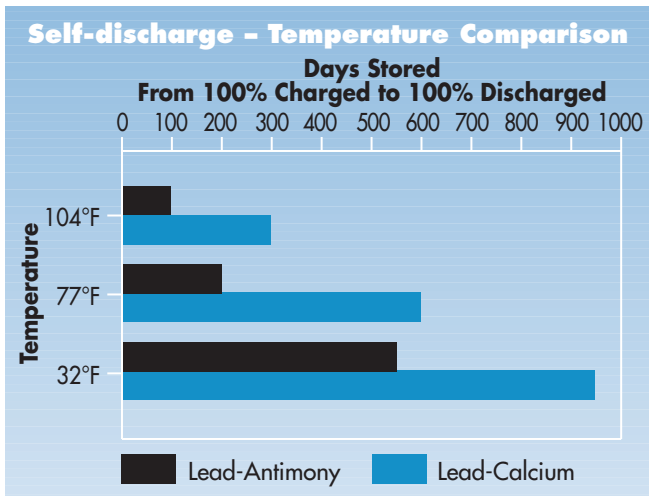

of 130°F are battery-killing. Been in a closed-up garage or storage building on a hot summer day recently? In many parts of the country, it's no trick for inside temperatures to reach that.

**Accessories:** Electrical accessories on some of today's newer and bigger bikes – clocks and computer memory, for example – will discharge the battery continuously, even when the ignition's off. The drain can be considerable. You can find out the drain, in milli-amperes, by disconnecting the negative terminal and putting a multimeter in line. It should look like this:

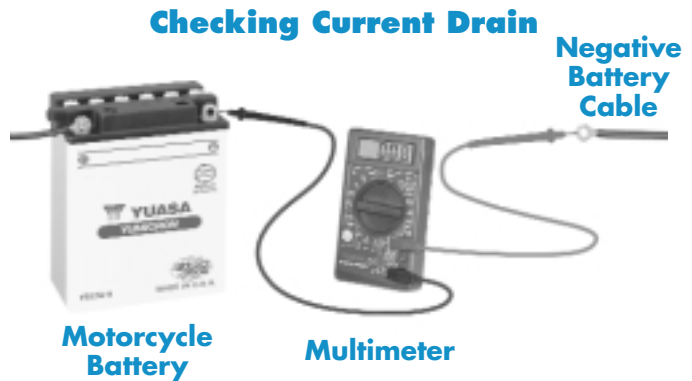

Keep in mind that at the same time accessories are drawing on the battery, the battery's self-discharging, too. The charts below show how fast a battery is discharged by self-discharge and by current drain:

Temperature	Self-discharge Approx. Number of Days From 100% Charged to 100% Discharged	
	Lead-Antimony Battery	Lead-Calcium Battery
104°F	100 Days	300 Days
77°F	200 Days	600 Days
32°F	550 Days	950 Days

Discharging Ampere	Current Drain (Y50-N18L-A) Days From	
	100% Charged to 50% Discharged	100% Charged to 100% Discharged
7 mA	60 Days	119 Days
10 mA	42 Days	83 Days
15 mA	28 Days	56 Days
20 mA	21 Days	42 Days
30 mA	14 Days	28 Days

**Current Drain**

12 Days x 0.030 Amps x 24 Hours = 8.64 AH

8.64 AH ÷ 20 AH (Y50-N18L-A) = **43.0% Available Capacity**

**PLUS (+)****Self-discharge**

12 Days ÷ 200 Days to 100% Loss = **6.0% Available Capacity**

**Total Loss**

Current Drain **43.0% Available Capacity**

Self-discharge +6.0% **Available Capacity**

Loss in 12 Days **49.0% Available Capacity**

Let's see what happens as the two work together to discharge a battery:

The battery, starting out 100% charged, has a 30mA discharge rate from electrical accessories on the motorcycle.

At an average outdoor temperature of 77°F a lead-antimony battery loses about half its capacity in only 12 days due to the combination of self-discharge and current drain. In another 12 days, it's completely dead. In other words, it doesn't take long for the double whammy of self-discharge/accessory drain to knock out a battery for good.

If current drain is measurable when the motorcycle is

turned off, you can do one of two things: disconnect the battery when the vehicle is in storage, or charge the battery every two weeks to a full charge. However, cycling – or continually recharging the battery – will shorten its life. Check the battery's condition with either a hydrometer or voltmeter (or a multimeter). The section on Testing a Battery has details.

Short Trips: What if you use the vehicle now and then – a couple of times a week for errands, or even daily for a short trip to work?

**You can't assume that occasional use or short trips (under 15 or 20 miles) will keep the battery charged.** In fact, they're probably going to add to drain, because the bike's charging system doesn't have enough time to make up for losses from normal starting and self-discharge. You're going to have to charge the battery more often. Maybe every month or so, depending on temperature.

Does the surface the vehicle's parked on, or a battery's sitting on, contribute to how well it holds a charge? You sometimes hear "experts" say parking on concrete will accelerate discharge. Bet them it's not so. Then collect. Concrete, macadam, wood, dirt, stones, sand – makes no difference. A battery discharges at the same rate, no matter what surface it's on.

And here's a hint: if a battery suddenly dies and there's no apparent reason for it, check the electrical system before you buy a new battery. One of life's little let-downs is to shell out dollars for a new battery when you didn't need to – and then still have the problem.

**POINTS TO REMEMBER**

- ❑ **Conventional lead-antimony batteries discharge @ 1/100 volt per day.**
- ❑ **Lead-calcium batteries discharge more slowly @ 1/300 volt per day.**
- ❑ **Higher temperatures mean faster discharge.**
- ❑ **Temperatures over 130°F kill batteries.**
- ❑ **Self-discharge and short trips cause drain.**
- ❑ **The more electrical accessories you add to a bike, the greater the current drain.**

## Ampere-Hour and Cold Cranking Amps

There are two battery ratings you need to know: capacity, or ampere-hour rating, and cold cranking amps, or cold start rating.

Ampere-hour rating (in the YUASA Applications book it's abbreviated as AH) is a battery's ability to deliver current for an extended period of time. Because low temperatures slow down the chemical reaction inside a battery, a battery will have a lower ampere-hour rating in cold temperatures than in warm ones.

Most small engine batteries are rated at 10 hours. That says they have to last at a given discharge rate that long. **A 14 ampere-hour battery, for example, discharges at a rate of 1.4 ampere-hours for 10 hours.** At this point, cell voltage has dropped to 1.75v per cell (10.5v for a 12v battery, or 5.25v for a 6v battery). Usually, the larger the plates, the greater the ampere-hour rating.

Cold start rating – the high rate or the cold cranking amps, abbreviated C.C.A. in the YUASA applications book – tells how well a battery can be expected to stand up to low temperatures. This rating depends on the number of plates and their surface area. The rating's arrived at by discharging a cold (0°F) battery at a high rate – for example, 150 amperes – while discharge is monitored with a voltmeter.

Generally, as displacement per cylinder increases, so does the cranking current – but since starting systems differ by model and manufacturer, the best advice is to check the application book for OE replacement. If a special application demands higher cranking power, select an appropriate alternate unit from the YUASA battery line. Once again, match battery features to needs. Cold start rating is important in a snowmobile. A lawn tractor owner probably doesn't care... unless he plows snow, too.

### POINTS TO REMEMBER

- ❑ **Capacity or ampere-hour rating: a battery's ability to discharge current over time.**
- ❑ **Cold cranking amps measure battery high rate performance in cold weather.**

## Inspecting a Battery

It's good policy to always inspect a battery before you test it. Here's how:

**1. Make sure the battery top is clean and dry.** That's not just because of looking pretty: a dirty battery actually discharges across the grime on top of the case. Use a soft brush and any grease-cutting soap or baking soda solution. Make sure plugs are finger tight

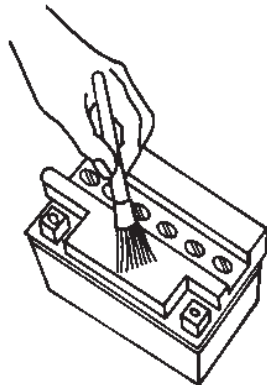

so cleaning materials don't get into cells and neutralize the acid.

**2. Inspect battery terminals, screws, clamps and cables for problems:** breakage, corrosion or loose connections. Clean the terminals and clamps with a wire brush and coat terminals with no ox grease.

**3. Inspect case** for obvious damages such as cracks or for leaks; look for discoloration, warping or raised top, which may indicate that battery has overheated or been overcharged.



**4. Check electrolyte level and add distilled water if necessary.** Don't add acid – only water. Before any tests, charge the battery so the water and electrolyte mix.

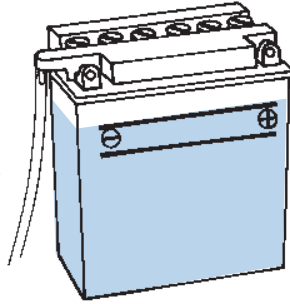

**5. Check the vent tube.** Make sure it's not kinked, pinched or otherwise obstructed. On a motorcycle, it should exit away from the drive chain and from below the swing arm. Small cuts in the tube near the battery vent are OK; they're an "emergency escape" for gas in case the tube becomes obstructed.

### POINTS TO REMEMBER

- Inspect before you test.**
- Dirt on top of case causes discharge.**
- Look for obvious damage to battery and connectors.**
- Add water if electrolyte is low.**
- Make sure vent tube is clear.**

## Battery Testing Devices

How much of a charge does a battery have? There are two easy and reliable ways to find out:

- 1) a hydrometer, which comes in floating ball and calibrated float types, or
- 2) a voltmeter (or multimeter, which gives DC voltage readings).

Which is best?

**If you're choosing between two hydrometers, opt for the calibrated float type.** It gives you an exact specific gravity reading (that is, the density of the electrolyte compared to water); that's much more accurate than floating balls. For readings on calibrated float and floating ball hydrometers, see "Methods of Checking Battery Condition" chart on the next page.

A voltmeter or multimeter can be used where a hydrometer can't. Most sealed VRLA or low maintenance batteries have to be tested with a voltmeter.

**Battery testing requires a voltmeter that can measure DC voltage.** Remember to always connect a voltmeter parallel to the circuit being tested, observing polarity; otherwise, the pointer will travel in the wrong direction. It's a good idea to periodically check a voltmeter against another one of known accuracy.

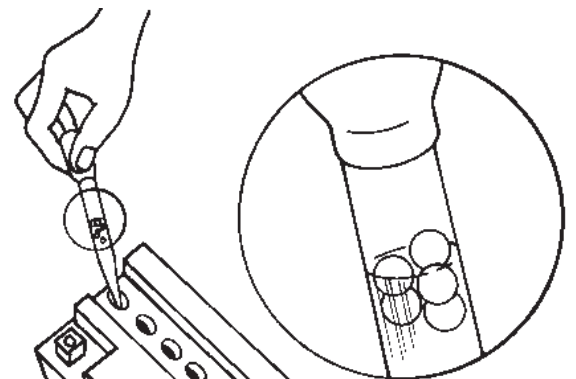

Hydrometer

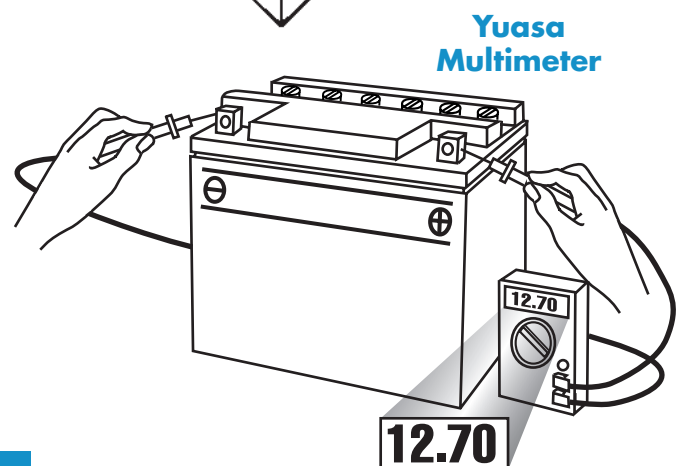

Yuasa  
Multimeter

12.70

## Battery Testing

There are two types of battery tests: **unloaded** and **loaded**. An unloaded test is made on a battery without discharging current. It's simplest and most commonly used. If you need a precise reading, loaded testing is the answer. It's more accurate.

**UNLOADED TESTING:** Check charge condition using either a hydrometer or voltmeter. With a voltmeter, voltage readings appear instantly to show the state of charge. Remember to hook the positive lead to the battery's positive terminal, and the negative lead to the negative terminal.

A hydrometer measures the specific gravity of each cell. **The specific gravity tells the degree of charge; generally, a specific gravity of about 1.265 to 1.280 indicates a full charge.** A reading of 1.230 to 1.260 indicates the battery should be charged before testing. The chart below shows the charge level as measured by syringe float hydrometer, digital voltmeter and five-ball hydrometer.

Methods of Checking Battery Condition			
State of Charge	Syringe Hydrometer	Digital Voltmeter	5-Ball Hydrometer
100% Charged w/Sulfate Stop	1.280	12.80v	5 Balls Floating
100% Charged	1.265	12.60v	4 Balls Floating
75% Charged	1.210	12.40v	3 Balls Floating
50% Charged	1.160	12.10v	2 Balls Floating
25% Charged	1.120	11.90v	1 Balls Floating
0% Charged	less than 1.100	less than 11.80v	0 Balls Floating

A battery's specific gravity changes with temperature. Ideally, readings should be taken at 77°F. Is it really going to matter if you're off a couple of degrees one way or another? Probably not. If you're working somewhere

that's uncomfortably hot or cold, it's time to use the old conversion factors: add .001 to the specific gravity reading for each 3°F above 77°F or subtract .001 from the specific gravity reading for each 3°F below 77°F. Cell voltage can be found by adding .84 to the specific gravity.

Note, too, that YUASA's "Sulfate Stop," a chemical additive that increases battery life by drastically reducing sulfate buildup, changes the specific gravity readings; they'll be higher than with ordinary batteries.

**Test sealed VRLA types with a voltmeter or multimeter.** If the stabilized open circuit voltage is below 12.5v, the battery needs charging. For a stabilized open circuit reading, first allow the battery to remain in an open circuit condition for at least 1 - 2 hours.

**LOADED TESTING:** There are two types of loaded tests for motorcycle batteries. You'll need a voltmeter or multimeter.

**Low-load test:** Basically, this means turning on the bike's lights and taking a voltage reading at the battery. Remember, hook positive (+) to positive (+), negative (-) to negative (-). The battery in a 12v system should have at least 11.5v DC with the lights on. A 6v system should have at least 5.75v DC. If voltage drops below these levels, it's time to charge.

**High-rate discharge test:** This is the best test of battery condition under a starting load. Use a load testing device that has an adjustable load. Apply a load of three times the ampere-hour rating.

At 14 seconds into the test, check battery voltage: a good 12v battery will have at least 10.5v, and a good 6v battery, at least 5.25v. If the reading's low, charge.

### POINTS TO REMEMBER

- ❑ Use a voltmeter or hydrometer to test state of charge.
- ❑ In extreme cold or heat, you'll have to adjust hydrometer readings.
- ❑ Battery can be tested with or without electrical load applied.
- ❑ Unloaded testing is simplest.
- ❑ Applying a load and reading voltage at battery is more accurate.

## Chargers and Charging

There's a simple rule of thumb about batteries, and if you're a dealer or a mechanic, you know that people ignore it all the time: for a battery to operate the way it's supposed to, it has to be fully charged before it's used... and kept fully charged throughout its life.

A charger basically brings a new battery, or a battery that has been discharged, to full capacity. Plugged into a wall socket, it sends direct current, flowing in the opposite direction of the discharge, into the battery.

Charging actually reverses the destructive chemical process that goes on as a battery discharges: the lead plates and electrolyte, which were being transformed into lead sulfate and water, are restored to their original composition. If a battery has been damaged – for example, it's badly sulfated, or the plates have been damaged from overheating or freezing – it may not accept a charge.

**TYPES OF CHARGERS:** There are five basic types of battery chargers. With all of them, hook the positive charger lead to the positive battery terminal, and the negative to the negative. Some chargers on the market deliver a low charging voltage that can't fully charge the battery; avoid them if you're buying a charger. A 12 volt, 900 mA charger will meet most needs.

Of course, too much of a charge can be a problem, too – it can “cook” a battery. For small engine starting batteries, don't use a charge greater than 2 to 2.5 amps for maintenance purposes. A badly discharged battery with very high internal resistance may never accept a charge from a standard charger. It would then require special charging equipment.

### ALWAYS OBSERVE PROPER SAFETY PRECAUTIONS WHEN CHARGING BATTERIES

**TRICKLE CHARGER:** This is the charger a consumer – as opposed to a battery retailer or garage – will usually have. It charges the battery at a fixed rate. Different ampere-hour batteries have different charge rates. **For most motorcycle and other small engine starting batteries, charge them at 1/10 of the rated ampere-hour values in the Yuasa Applications Book, see example on page 12 for ratings.**

**Battery voltage increases with the amount of charge.** Find charging time for a completely discharged battery by multiplying the ampere-hour rating by 1.3 when charging with standard current. The chart on page 21 shows the approximate time needed to fully charge lead-antimony batteries using a trickle or taper charger.

The chart on page 32 shows the approximate time needed to fully charge sealed VRLA batteries.

Test the battery during charging, and continue charging until all cells are gassing. Use either a voltmeter (or multimeter) or hydrometer. The specific gravity of the electrolyte in all cells in a fully-charged battery should come to at least 1.265 in a conventional battery and 1.280 in a YuMicron and sealed VRLA battery with Sulfate Stop.

### Specific Gravity Reading Using a Hydrometer

State of Charge	Electrolyte Temperature			
	80°F		40°F	
	CX & YuMicron	Conventional	CX & YuMicron	Conventional
100%	1.27/ 1.28	1.26/ 1.27	1.28/ 1.29	1.27/ 1.28
75%	1.22/ 1.23	1.21/ 1.22	1.23/ 1.24	1.22/ 1.23
50%	1.17/ 1.18	1.16/ 1.17	1.18/ 1.19	1.17/ 1.18
25%	1.13/ 1.14	1.12/ 1.13	1.14/ 1.15	1.13/ 1.14
0%	1.11/ or less	1.10/ or less	1.12/ or less	1.11/ or less

During charging, check the electrolyte level periodically and add water – preferably distilled – to keep the electrolyte level up to the line. If the battery becomes hot to the touch, stop charging. Resume after it has cooled.

Note that permanently sealed batteries – YUASA's sealed VRLA battery, for example – generally can be tested only with a voltmeter or multimeter. These batteries are fully charged when the voltage peaks and then begins to fall.

**Unless using an automatic charger, do not hook a battery to a trickle charger and leave it unchecked for longer than overnight.**

After about eight hours maximum, careful monitoring is required.

Caps need to be replaced finger tightened after charging's done.

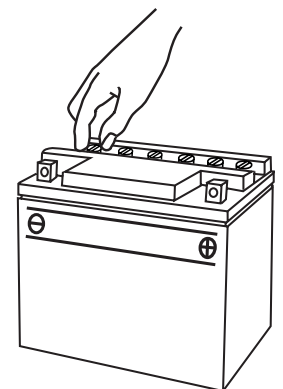

## Inspecting, Testing and Charging

**TAPER CHARGER:** Similar to the trickle charger, the automatic taper charger charges at a fixed voltage. As the battery's voltage increases with the amount of charge, the current drops accordingly.

A drawback of both the automatic taper and trickle chargers is speed... they don't have it. As the chart on page 21 shows, it can take days to bring a discharged battery up to 100%. Here, too, check batteries for overheating as they charge.

**CONSTANT CURRENT CHARGER:** A professional-quality charger, the constant current makes charging simple. It maintains a constant supply of current to the battery at all levels of charging. You select the charging current. As the battery voltage increases with the amount of charge, this charger automatically increases the charging voltage to maintain the current output.

**CHARGER/MAINTAINER:** This type of charger monitors the voltage constantly during charging and

standby modes. When battery voltage reaches a specified low level, the charger/maintainer then delivers a full charge. Then when the battery gets to the specified voltage, it automatically drops to a float charge.

**HIGH RATE CHARGER:** Not for use with small engine starting batteries. They force a high current into the battery, which can lead to overheating and plate damage.

**Battery Voltage Reading Using a Voltmeter**

State of Charge	Sealed VRLA	CX & YuMicron	Conventional
100%	13.0v	12.7v	12.6v
75%	12.8v	12.5v	12.4v
50%	12.5v	12.2v	12.1v
25%	12.2v	12.0v	11.9v
0%	12.0v or less	11.9v or less	11.8v or less

### POINTS TO REMEMBER

- ❑ Fully charge battery when new and keep it fully charged.
- ❑ Test charging batteries as necessary for overheating, water and state of charge.
- ❑ Trickle and taper chargers are generally slow.
- ❑ Constant current and pulse chargers are professional quality.
- ❑ High rate charger can cause battery damage.

## Charging a New Standard Battery

The most important thing to remember about charging a new battery is do it!

A battery out of the box with only adding electrolyte is approximately 80% charged. Our recommendation is to initial charge, bringing the battery to 100% before use.

This completes the electrochemical process. However, a long ride with a regulated charging system may also bring the battery's capacity to a higher level.

**Note: See "Section 5" for charging sealed VRLA batteries.**

The rule of thumb is to charge a new battery for three to five hours at a rate equal to 1/10 of its rated capacity. But there are a lot of exceptions to that rule, as this table shows:

### Quick Charges

What about quick charging? The quick answer is

**don't.** We don't recommend it, and here's why: only the surface area of the battery plates can be quick charged. A lower current charges the battery more uniformly. That means better performance. Also, excessive charging rates increase the chance of overheating, which can mean battery damage.

Charging Times						
State of Charge	Battery Types					
	12N10	12N12	12N14	YB18	YB16	Y50
Approximate Charge Times (Hours) Using a "Trickle" (0.25 Amp) Charger						
75%	13	15	18	23	24	25
50%	25	30	35	45	48	50
25%	38	45	53	68	71	75
0%	50	60	70	90	95	100
Approximate Charge Times (Hours) Using a 1 Amp Taper Charger						
75%	6	7	8	10	10	11
50%	11	13	14	18	19	20
25%	15	18	20	26	27	28
0%	20	23	27	34	35	37
Approximate Charge Times (Hours) Using a 1 Amp Constant Current Charger						
75%	3	4	4	6	6	6
50%	6	8	9	11	12	13
25%	9	11	13	17	18	19
0%	13	15	18	23	24	25

### POINTS TO REMEMBER

- A new battery after activation is approximately 80% charged.
- Initial charging is always recommended. NEVER quick charge.
- Charge a new battery at a rate equal to 1/10 of its rated capacity.



## Maintenance and Storage

### Monthly Maintenance for Conventional and YuMicron Types

Batteries don't demand a lot of attention. But not giving your battery the attention it needs can leave you stranded... or poorer by the cost of a new battery.

How often should you maintain a battery? About monthly under usual conditions. However, recharging is necessary when lights get dim, when the starter sounds weak, or when the battery isn't used for more than two weeks.

Important as it is, there's really not much to battery maintenance. Basically, just follow the procedure outlined in the section "Inspecting a Battery."

That means:

- Check electrolyte level.
- Keep the top free of grime.
- Check cables, clamps and case for obvious damage or loose connections.
- Clean terminals and connectors as necessary.
- Make sure exhaust tube is free of kinks or clogs.
- Replace caps, **finger tighten only**.

Then, test the battery with either a hydrometer or voltmeter. Keep it charged to 100%.

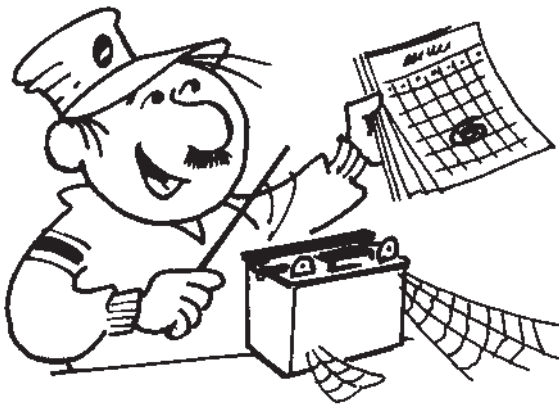

### Storage

**If the vehicle is in storage or used infrequently, disconnect the battery cable.** That eliminates drain from electrical equipment. Check battery every two weeks and charge as necessary.

For extended storage, remove the battery from the vehicle and charge to 100%. Charge the battery every month if stored at temperatures below 60°F. Charge every two weeks if stored in a warm area (above 60°F). Make sure batteries are stored out of reach of children.

### Sulfation and Freezing

Two of the biggest battery killers – sulfation and freezing – aren't a problem if the battery is properly maintained and water level is kept where it should be.

**Sulfation:** This happens because of 1) continuous discharging, or 2) low electrolyte levels.

Let's back up just a minute: we said earlier that discharge turns the lead plates into lead sulfate. This lead sulfate is actually a crystal. If the discharge continues uninterrupted, the sulfate crystals grow and blossom into sulfation – and a problem. The section titled "Reasons for Self-discharge" has the gory details.

Much the same happens if the fluid level is too low, which exposes the plates to air. Then the active lead material oxidizes and sulfates, and it doesn't take long before it won't hold a charge. (Low electrolyte levels cause another problem, too: acid in the electrolyte becomes more concentrated, causing material to corrode and fall to the bottom. In sufficient quantity, it will short out the battery.)

**Keeping a battery charged, disconnecting the battery cable during storage, and keeping electrolyte levels up eliminate the problem.**

For added protection, YUASA's YuMicron, YuMicron CX and Sealed VRLA batteries are treated with a special chemical formula called "Sulfate Stop." This dramatically reduces sulfate crystal buildup on plates. The result: longer battery life.

How good is Sulfate Stop?

We simulated a constant discharge condition on two batteries with a 10-watt bulb.

Even after being totally drained for a week, the battery with Sulfate Stop made a 90% recovery.

The untreated battery: useless.

**Freezing:** It shouldn't bother you – unless a battery is inadequately charged. Looking one more time at the discharge process, remember that electrolyte acid becomes water as discharge occurs. Now, it takes Arctic temperatures to freeze acid. But water... as we all know, freezing starts at 32°F. A sign of this is mossing – little red lines on the plates. Freezing can also crack the case and buckle the plates, which means the battery is permanently damaged.

**A fully-charged battery can be stored at sub-freezing temperatures with no damage.** As the chart at right shows, it takes -75°F to freeze electrolyte in a charged battery. But at just a couple degrees below freezing – at +27°F – a discharged battery's electrolyte turns to ice. That's a difference of more than 100°F between the low temperatures a charged and discharged battery can stand.

At temperatures such as these, incidentally, the self-discharge rate of a battery is so low that a recharge usually isn't needed for months. But to stay on the safe side, test.

#### Electrolyte Freezing Points

##### Specific Gravity of Electrolyte

##### Freezing Point

1.265	-75°F
1.225	-35°F
1.200	-17°F
1.150	+ 5°F
1.100	+18°F
1.050	+27°F

### POINTS TO REMEMBER

- ❑ **Monthly maintenance and testing are a must.**
- ❑ **Most important: make sure battery is charged and fluid level is correct.**
- ❑ **Disconnect cables or pull battery for storage.**
- ❑ **Keep fully charged to prevent sulfation and freezing.**

# Sealed VRLA Batteries

## New Generation Battery Technology

Yuasa's innovative sealed VRLA (Valve Regulated Lead Acid) batteries are a new generation made possible by advanced gas recombinant technology. These include the YT and YI series batteries. We refer to them as "sealed VRLA batteries" here.

Sealed VRLA batteries are easy to activate and maintain. But, keep these points in mind:

1. There are important differences in activating a sealed VRLA battery. Be sure to follow the instructions in this section.
2. While Yuasa sealed VRLA batteries dramatically reduce the need for maintenance, they do need periodic charging. It's important to remember this and to know how to go about it.
3. When considering upgrading to a sealed VRLA battery that did not come OE in your vehicle, **check to make sure your charging system has a regulated output between 14.0 - 14.8v.**

Let's take a closer look at Yuasa's innovative sealed

VRLA batteries... and what makes them special.

### Features

The sealed VRLA battery is the battery for vehicles that may be stored for long periods (riding mowers, personal watercraft, or scooters or cycles during the off-season, for example), or where spills could be a problem (ATVs or personal watercraft). YUASA's sealed VRLA batteries deliver:

- **No topping** – Fill it just once, to activate. No need to check electrolyte level or add water ever again.
- **Reduced self-discharge** – Grids manufactured from a special lead-calcium alloy hold the charge longer – a real plus with storage or occasional use.
- **Easy, instant activation** – The "one-push" electrolyte container makes filling a snap.
- **Enhanced safety** – A safety valve vents gases produced by overcharging. In case of fire, the flame arrestor disk minimizes explosion risk.

### SEALED VRLA BATTERY CONSTRUCTION

#### PATENTED SEALED POST

prevents acid seepage, reduces corrosion – extends battery life.

#### HEAT SEALED CASE TO COVER

protects against seepage and corrosion – bonded unit gives extra strength.

#### POLYPROPYLENE COVER AND CONTAINER

assures reserve electrolyte capacity for cooler operating temperatures; gives greater resistance to gas and oil – and impact in extreme conditions!

#### SAFETY VALVE/ FLAME ARRESTOR

relieves excess pressure.

#### THRU-PARTITION CONSTRUCTION

provides shorter current path with less resistance than "over the partition" construction – you get more cranking power when you need it!

#### SPECIAL ACTIVE MATERIAL

is compounded to withstand vibration, prolong battery life and dependability.

#### SPECIAL GRID DESIGN

withstands severe vibration, assures maximum conductivity.

#### SPECIAL SEPARATOR

makes the battery spill-proof. Valve regulated design eliminates water loss and the need to refill with acid.

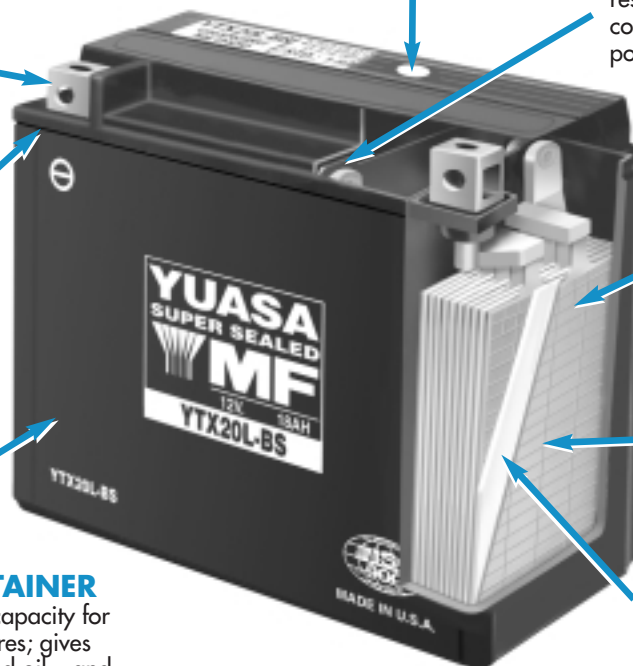

- **Compact design** – High efficiency in a small package, with no vulnerable exhaust tubes or other protrusions to break or kink.

### How a Sealed VRLA Battery Differs from Conventional Types

Some of a sealed VRLA battery's differences are obvious. It's noticeably more compact. The reason: no free electrolyte, making it more "volume efficient" – a fancy way of saying it can be smaller. Since the battery is filled with electrolyte just once (at activation), then sealed, you won't find a row of filling plugs. Instead, a single sealing plug strip permanently covers filler ports. Also, there are no vent tubes – after all, these batteries are sealed!

But as with any magic, there's more than meets the eye. The heart of a sealed VRLA battery is what you don't see.

1. The plates are comprised of special lead-calcium alloy grids and charged active material. Lead-calcium reduces self-discharge – the battery holds its charge longer. The construction of the sealed VRLA battery causes freed gas to recombine inside the battery instead of being vented... allowing the battery to be sealed.
2. Separators are made of a special fiber with superior heat and acid resistance. These special separators make the battery non-spillable.
3. Sealed VRLA batteries have an internal safety valve. If battery pressure soars due to accidental overcharging, it opens to release excess gas, preventing a battery rupture.

The unique design affects what happens inside the battery.

The basic discharge-charge cycle is still going on... that's what makes any battery tick. But to understand what's different, let's do a little review:

A battery is basically a box containing lead plates. Some plates have a positive (+) charge, some negative (-). They're immersed in a current-conducting electrolyte solution that sets off the electrochemical process that produces electricity. Think of a battery as a machine that produces electricity through a continuous process of charging and discharging.

During discharge, sulfuric acid electrolyte solution reacts with the lead plates, turning them into lead sulfate. The electrolyte – sulfuric acid solution made up of hydrogen, sulfur and oxygen – gives up its sulfur and some of its oxygen and turns to water.

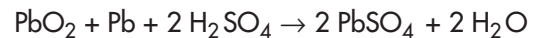

The process reverses with charging. Electrolytes and plates return to their original composition. The charging current breaks down water into its component gases: hydrogen (from the negatively charged plate) and oxygen (from the positive plate). Gases escape out the vent tube. With a conventional battery, water is added to replace that loss.

Here's the real secret of a sealed VRLA battery: the negative plate never becomes fully charged... so, no hydrogen gas. The positive plate still makes oxygen, but instead of being forced out the vent tube, it reacts with the charged active material to become water again. That's "gas recombinant technology." That's the magic of YUASA's non-spillable, sealed VRLA battery.

### POINTS TO REMEMBER

- ❑ **Gas Recombinant technology produces a more compact battery.**
- ❑ **After activation, no need to check electrolyte or add water.**
- ❑ **Sealing strip is permanently inserted – it's never removed.**
- ❑ **Gas is recombined in the battery; there's no vented gas and vent tube.**

## Activation and Installation

Activating sealed VRLA batteries is easy, although a little different from conventional activation. For problem-free start-up and operation, follow the procedure outlined here. A few things to keep in mind before you get rolling:

- **Store the battery in a cool, dry place out of direct sunlight.**
- **Do not remove the foil sheet covering the filler port until activation.**
- **After removing the electrolyte container cap strip, do not peel, pierce or otherwise open the sealed electrolyte receptacles. Don't separate the individual cells.**
- **Read electrolyte handling instruction and precautions on the label.**

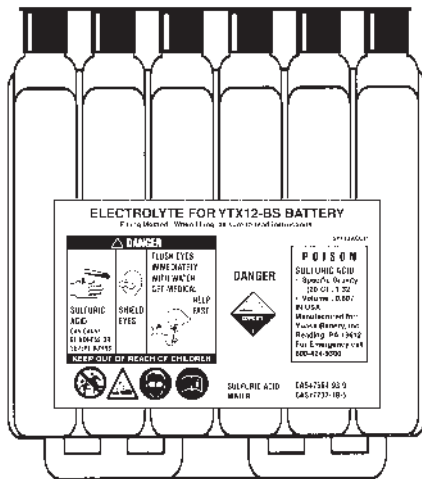

- **Use only the electrolyte container that comes with the battery.** Sealed VRLA battery electrolyte is a higher concentration of sulfuric acid. All sealed VRLA battery electrolyte containers aren't the same. Each contains the proper amount of electrolyte for its specific battery.
- **Always wear plastic gloves and protective eyewear.** No Smoking, see page 9 for full safety instructions. Of course, don't forget safety precautions when storing or handling electrolyte solution.

### To Activate a Sealed VRLA Battery

1. Place the battery on a level surface. Battery must be out of the vehicle.
2. Remove electrolyte container from vinyl bag. Remove the strip of caps. **Put the strip aside – you'll use this later as the battery sealing plug.** Use only the dedicated container that comes with the battery. It contains the proper amount of electrolyte for your specific model – important to service life and operation. Do not pierce or otherwise open the sealed cells of the electrolyte container. Do not attempt to separate individual cells.
3. Place electrolyte container, sealed top of the cells down, into the filler ports of the battery. Hold the container level, push down to break the seals. You'll see air bubbles as the ports fill. **Do not tilt the electrolyte container.**

**Warning: Improper activation or excessive overcharging (possibly by equipment failure) could cause damage to the battery or vehicle by forcing acid out of the safety vent.**

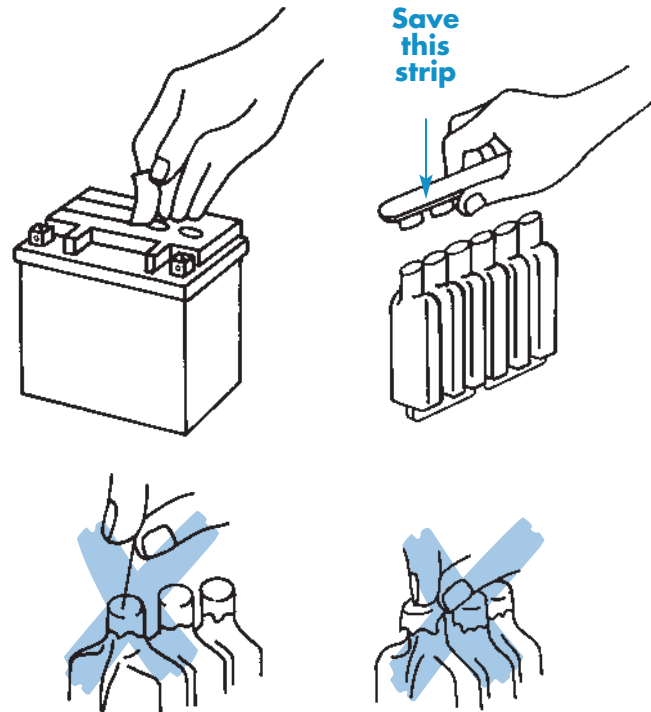

See next page.

## Sealed VRLA Batteries

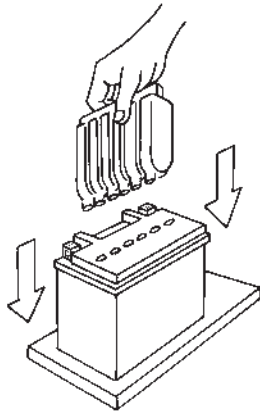

**4. Check the electrolyte flow. Keep the container in place for 20 minutes or longer until it empties completely.** If no air bubbles are coming up from the filler ports, or if container cells haven't emptied completely, tap the container a few times. Don't remove the container from the battery until it's empty. The battery requires all the electrolyte from the container for proper operation. Make sure the electrolyte container empties completely.

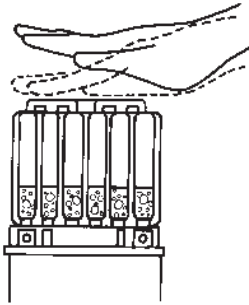
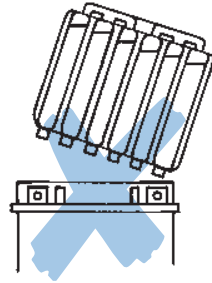

**5. Remove the container. For batteries 3 - 12 AH, let stand for at least 30 minutes. For batteries greater than 12 AH, allow the battery to stand a minimum of 1 HOUR.** This allows the electrolyte to permeate into the plates for optimum performance. Yuasa sealed VRLA batteries have the amp hours printed right on the front of the battery.

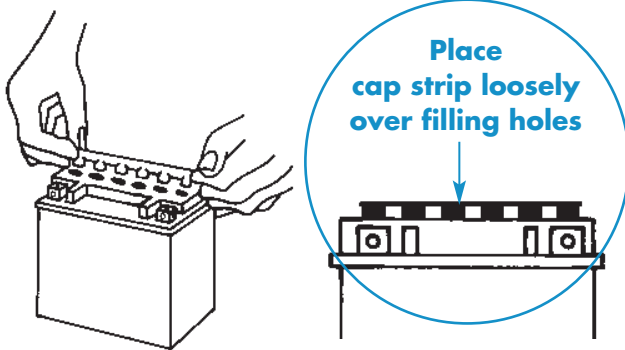

**6. Newly activated sealed VRLA batteries require an initial charge.** After adding electrolyte, a new battery is approximately 80% charged. Place cap strip loosely over the filling holes as shown in drawing above. Immediately charge your battery after the "stand" period, to bring it to a full state of charge. **See "Charging a Newly Activated Sealed VRLA Battery" on page 31.**

**After charging is completed, press down firmly with both hands to seat the caps (don't pound or hammer).**

The battery is sealed. There is no need to remove the strip of caps or add electrolyte for the life of the battery.

**7.** The graph below shows an open circuit voltage characteristic of a sealed VRLA battery just after the electrolyte is filled.

If the battery is only filled with electrolyte, but not being given a supplementary charge, the open circuit voltage will be somewhere around 12.5 to 12.6v, as shown in the graph below. The reasons for the voltage being low are that:

- **The capacity reached by filling with electrolyte is about 80% of the fully charged capacity.**
- The electrolyte around the plates gets its concentration lowered temporarily.

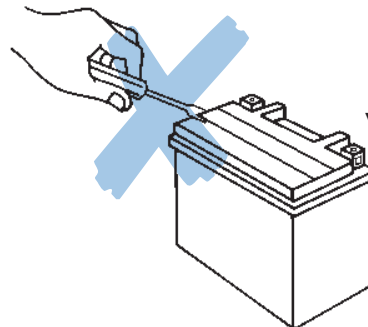
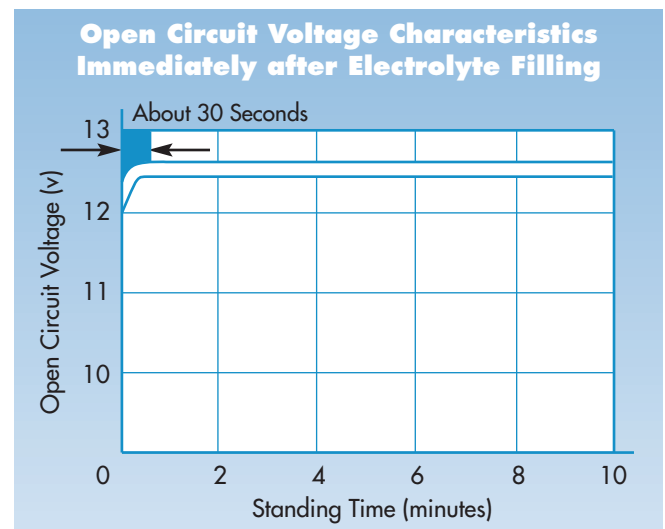

**Remember: unlike a conventional battery, the sealed VRLA battery won't be topped off during its life. Never pry off sealing caps: it's dangerous and damaging.**



## Measuring Voltage

How healthy is your sealed VRLA battery? Since a sealed VRLA battery is sealed – and the sealing caps are never removed – you won't be able to check the state of the charge by the old hydrometer-and-specific-gravity test. Rather, use a voltmeter or multimeter to measure DC voltage. It should be of class 1 accuracy or better. Some basics to keep in mind:

- Check voltage using a voltmeter. Readings for a charged, newly-activated battery should be 12.8v or higher after the battery is charged and **sits for at least 1 - 2 hours**. If less, it needs an additional charge.
  - The graph top right shows open circuit characteristics of the sealed VRLA battery after end of charging using a constant current charger set to the standard current of the specific battery. As shown, the open circuit voltage is stabilizing 30 minutes after end of charge.
- Therefore, to determine the state of charge and the health of the battery, measure the open circuit voltage 1 hour after end of charge.
- For a battery that has been in use, refer to the graph bottom right to determine state of charge from open circuit voltage.

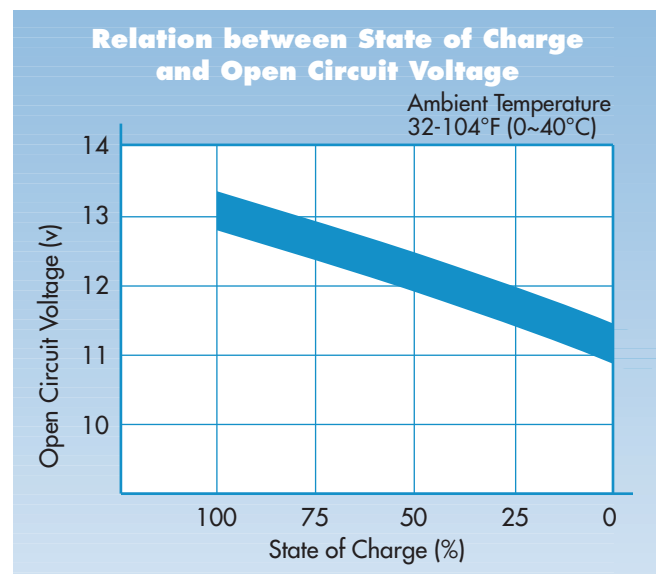
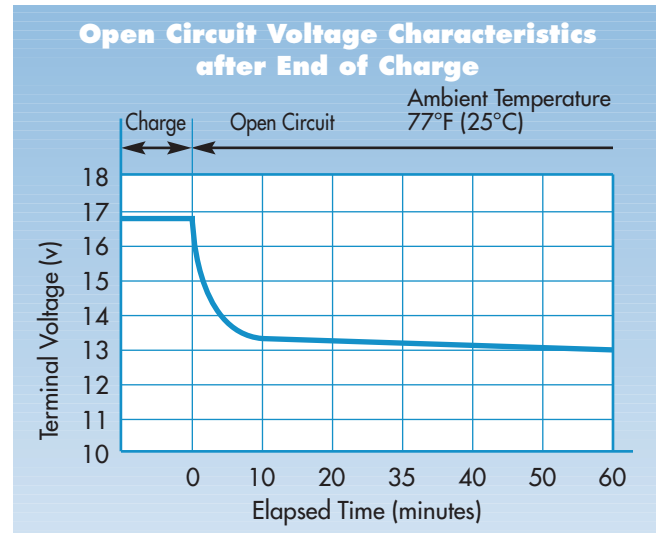

### POINTS TO REMEMBER

- ❑ Use a voltmeter to determine state of charge. Because sealing caps are never removed, you can't test specific gravity.
- ❑ Don't use a quick charge for initial activation.
- ❑ A battery that has just been activated or charged needs to stabilize 1 hour for an accurate voltage reading.

## Discharge Characteristics

Think about what types of vehicles a sealed VRLA battery goes into: most aren't like the family car, driven day-in, day-out. They're probably used once in a while, or maybe even stored for weeks or months at a time.

That demands a special kind of battery – one with extra power to reliably start that engine, every time. In YUASA's sealed VRLA batteries, the plate groups are specially designed to deliver that. The graph to the right shows the increase in discharge time of a sealed VRLA battery compared to a conventional Yumicron battery at both cold and room temperatures. The graph below shows the cold temperature performance of the sealed VRLA battery as the load increases. "C" equals the Amp Hour Capacity Rating of the battery.

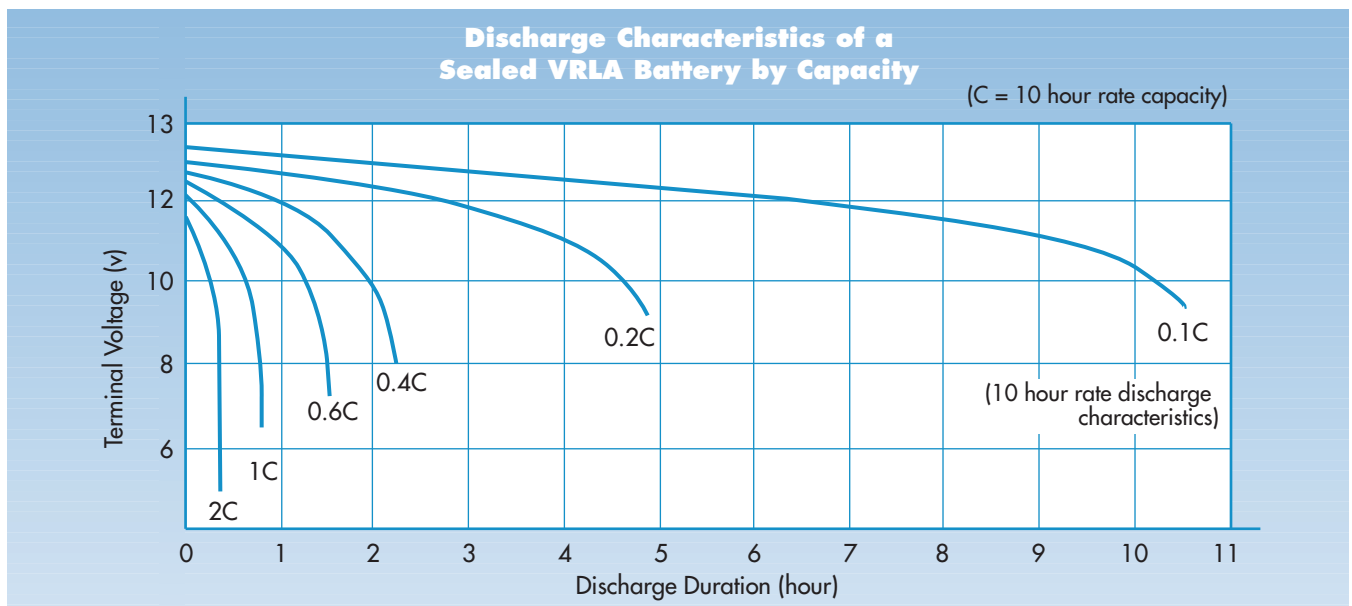
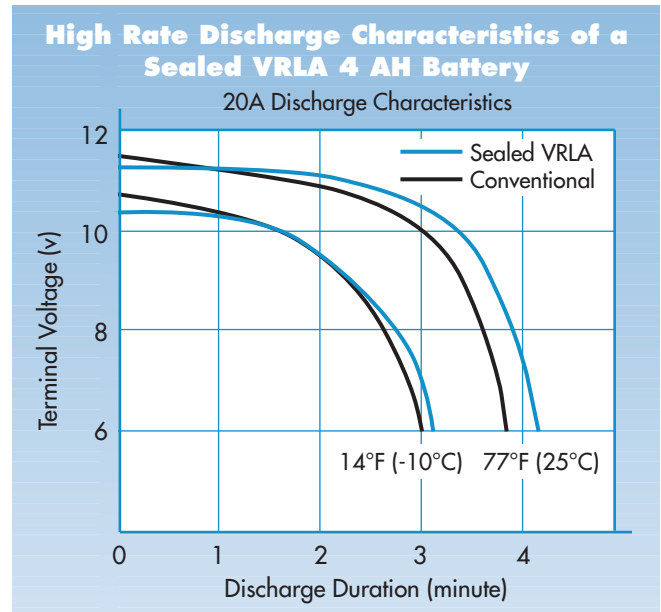

Starting the engine is a big part of the battery's job, but not all. Electrical accessories and safety systems – lights and horn – need a stable supply of electricity. Now you're concerned with the battery's "low rate discharge characteristics." This steady, low rate discharge is

measured in "10-hour rate discharge." The graph above shows the discharge characteristics of YUASA's YT or YI sealed VRLA batteries at different current rates. Note that battery capacity is a function of the current being used (or discharge current) x time.

## Self-discharge

Constant self-discharge is a fact of life for all batteries. They lose strength as they sit there doing nothing. The good news is that lead-calcium technology in a sealed VRLA battery slows down the self-discharge process substantially. Conventional lead-antimony batteries discharge at about 1/100 volt a day... the lead-calcium sealed VRLA battery, 1/300 volt per day. Looking at it another way, a conventional battery fully charged and stored for a month will lose roughly a third of its charge; the sealed VRLA battery handled the same way would lose about 10%.

Remember, too, ambient temperature affects battery discharge. Higher the temperature, quicker the discharge – for all batteries.

So, the sealed garage or storage shed with the sun beating down on it isn't doing any favors to the battery in your vehicle. Excessive heat will prematurely shorten the life of the battery.

Some people figure sealed VRLA batteries are so good, there's no need to worry about routine charges. Flattering, but wrong. Forgetting routine charging can mean a one-way ticket to the battery graveyard.

Lead-calcium technology definitely slows self-discharge, but a combination of heat and idleness will still drain a sealed VRLA battery, like the conventional one. You'll find step-by-step charging instructions later in this section.

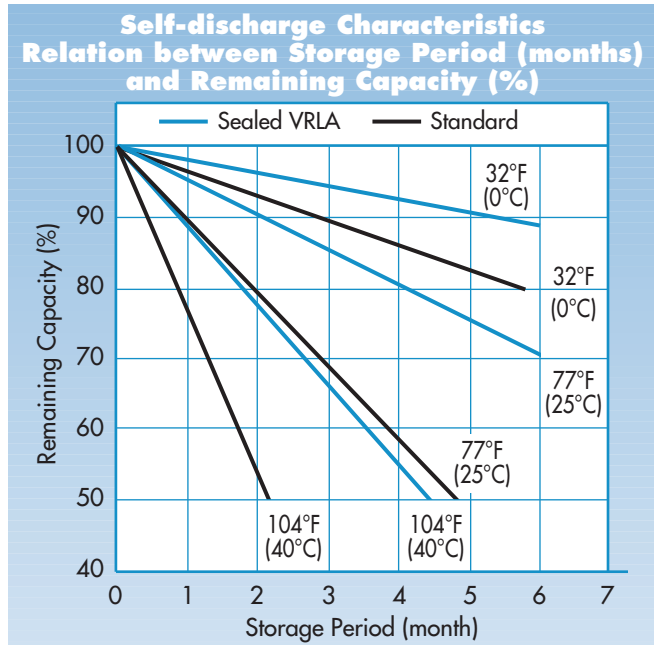

### POINTS TO REMEMBER

- ❑ **“High rate discharge” sealed VRLA batteries deliver extra starting power.**
- ❑ **Lead-calcium technology substantially slows self-discharge.**
- ❑ **Routine charging is required to maintain a full charge.**

## Choosing a Charger

Match your sealed VRLA battery to the right charger. The wrong one can cause permanent damage and poor performance.

Yuasa offers a complete line of chargers to activate and maintain your battery to factory specifications.

- Do not use a larger than recommended amp charger to reduce charging time. That permanently damages the battery and voids the warranty.
- **To find recommended current output in amps, divide battery amp hour capacity rating by 10. Example: 14 AH ÷ 10 = 1.4 amp current.**

Yuasa sealed VRLA batteries have the amp hours printed right on the front of the battery. If you're not sure, refer to application manuals at the dealer. Select the charger that comes closest to the value of that figure.



**Yuasa 900 mA  
Automatic Charger**

**Yuasa 1.5 Amp  
Automatic Charger**

## Charging a Newly Activated Sealed VRLA Battery

Sealed VRLA batteries require an initial charge. If you are using a constant current charger, refer to the standard (STD.) charging method printed on the battery. If you are

using an automatic type taper charger, check to make sure that the charger current (amps) is equal to or greater than the standard (STD.) charging method listed on the battery.

### CHARGING INSTRUCTIONS FOR NEWLY ACTIVATED SEALED VRLA BATTERIES

#### YTX20L-BS CHARGING METHOD

● THIS IS A SEALED BATTERY; THE SEALING CAPS SHOULD BE CONSIDERED PERMANENT.  
● DO NOT REMOVE THE CAPS TO ADD WATER OR TO CHARGE THE BATTERY; CHARGE AT 12V AT THE AMPERAGE AND HOURS STATED BELOW.

**STD.: 1.8A x 5~10h or QUICK: 9.0A x 1.0h**



These batteries are a sealed VRLA construction – which means:  
**NEVER REMOVE THE SEALING STRIP AFTER CHARGING IS COMPLETED!**  
If the battery gets very hot to the touch, cease charging and allow battery to cool down.

Check voltage using a voltmeter. Readings for a charged, newly-activated battery should be 12.8v or higher after the battery is charged and **sits for at least 1 - 2 hours.**  
If less, it needs an additional charge.

***Yuasa Automatic Chargers and Accessories are the safest and most convenient method for error proof charging and battery maintenance.***

## Routine Charging

The single most important thing to maintaining a sealed VRLA battery is **don't let it sit discharged: keep it fully charged.** A sealed VRLA motorcycle battery should be kept to near fully charged for peak performance. In fact, it can need charging more often than a car battery because it's probably not used routinely and, therefore, not "automatically" charged.

Use the following guidelines for boost charge. Always verify battery condition before charging, and 30 minutes after charging.

- A fully charged battery should read 12.8v or higher after battery has been off the charger 1 - 2 hours.

**OVERCHARGING CAN HARM YOUR BATTERY BEYOND RECOVERY.**

A word on overcharging: *don't*. Because of the characteristics of a sealed VRLA battery, too much of a boost charge will decrease the volume of electrolyte. The longer the overcharge time, the greater the drop in electrolyte – and starting power.

Water can't be added to the sealed VRLA battery to make up the difference. Overcharging can warp plates, making future charging difficult or impossible. Watch charging times carefully, or ideally, use a Yuasa Automatic Charger. Always stop charging if the battery becomes really warm to the touch. Let it cool down 6 - 12 hours and resume charging.

State of Charge	Voltage	Action	Charge Time* (Using a constant current charger @ std. amps specified on the battery)
100%	12.8v - 13.0v	None Check at 3 months from date of manufacture	None Required
75% - 100%	12.5v - 12.8v	May need slight charge, if no charge given, check in 3 months	3 - 6 hours
50% - 75%	12.0v - 12.5v	Needs charge	5 - 11 hours
25% - 50%	11.5v - 12.0v	Needs charge	At least 13 hours verify state of charge
0% - 25%	11.5v or less (see special instructions on page 33)	Needs charge	20 hours

\* Charging times can vary depending on type of charger. Follow the charger's instructions.

### Caution:

Always wear safety glasses and charge in a ventilated area. If battery gets really warm to the touch, discontinue charging and allow battery to cool down. No sparks, flames or smoking when charging.

## Charging Instructions for Sealed VRLA Batteries with Voltage of 11.5 or Less

Batteries with voltage below 11.5v may require special equipment and procedures to recharge.

In charging an overdischarged battery having a terminal voltage of 11.5v or lower, its internal resistance may be too high to charge at a normal charge voltage. Therefore, it may be necessary to raise the voltage of the battery initially (25v as a maximum), and charge

for approximately 5 minutes. If the ammeter shows no change in current after 5 minutes, you need a new battery.

Current flowing into the battery at high voltage can become excessive. Monitor amperage and adjust voltage as necessary to keep current at the battery's standard amp rating. Charge for approximately 20 hours.

### How to determine battery condition after boost charge.

Determine the condition of a sealed VRLA battery at least 1 - 2 hours after the charge by measuring the terminal voltage according to the table below.

Criteria	Judgement
12.8v or higher	Good
12.0 - 12.8v or lower	Charge insufficient → Recharge
12.0v or lower	Unserviceable → Replace

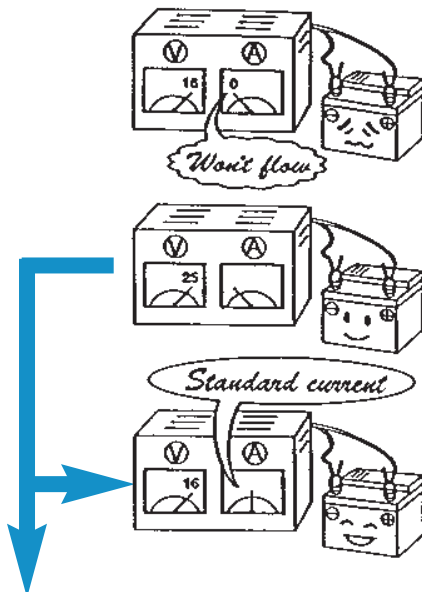

**Adjust voltage so that current will be at standard amps after 5 minutes.**

## Routine Maintenance for Sealed VRLA Batteries

### Check voltage periodically using a voltmeter.

- Recommended every 3 months from date of activation, or 3 months from date of manufacture for batteries activated at the factory. Keep in mind, higher storage temperatures cause faster self-discharge and require checking more often.
- If you plan to store your vehicle for an extended time, make sure your battery is fully charged.
- Fully charged should read 12.8v - 13.0v after standing 1 - 2 hours.
- When a battery is in storage, check and charge it if the voltage drops below 12.5v for YTX batteries.

Beyond that, maintenance is the same as for any battery, except you don't have to worry about electrolyte:

- Keep the battery top free of grime.
- Check cables, clamps and case for obvious damage or loose connections.
- Clean terminals and connectors as necessary.
- For storage, pull battery or disconnect battery cable.



**Acid** Sulfuric acid, used to describe the electrolyte or liquid in a cell.

**Active Materials** Materials in a battery that react chemically to produce electrical energy: they are lead peroxide (positive) and sponge lead (negative).

**Activation** Making a dry cell functional by adding electrolyte.

**AGM** Absorbed glass mat.

**Air Oxidized** A charged negative plate that has been removed from electrolyte and permitted to discharge in an air atmosphere. Plates must then be recharged before they are capable of producing useful electrical energy.

**Alloy** A combination of two or more metals. See **Antimonial Lead Alloy** and **Calcium Lead Alloy**.

**Ambient Temperature** The surrounding temperature, usually refers to room temperature.

**Alternating Current** A pulsating electric current in which direction of flow is rapidly changed, so the terminal becomes in rapid succession positive, then negative. Abbreviated AC.

**Ammeter** An instrument for measuring electrical current.

**Ampacity** Current carrying capacity in amperes.

**Ampere** The unit of electrical current equal to the steady state current produced by one volt applied across a resistance of one ohm.

**Ampere-Hour** A measure of the volume of electricity, being one ampere for one hour. It is used to express battery capacity, and is registered by an ampere-hour meter; it can be obtained by multiplying the current in amperes by length of time that the current is maintained.

**Ampere-Hour Capacity** The number of ampere-hours that can be delivered by a storage battery under specified conditions as to temperature, rate of discharge and final voltage.

**Ampere-Hour Efficiency** The electrochemical efficiency of a storage battery expressed as the ratio of ampere-hours output to the ampere-hours input required for recharge.

**Ampere-Hour Meter** An instrument that registers the quantity of electricity in ampere-hours.

**Anode** An electrode through which current enters any non-metallic conductor. Specifically, an electrolytic anode is an electrode at which negative ions are discharged, positive ions are formed, or at which other oxidizing reactions occur.

**Antimonial Lead Alloy** A commonly used alloy in battery castings. The percentage of antimony varies from 1/2% to 12%. Other substances are present in small quantities, either as inescapable impurities or by design to improve the properties of the cast part.

**Antimony** A hard, brittle, silver-white metal with a high luster from the arsenic family.

**Assembly** 1. Combining various parts into a finished battery. 2. Any particular arrangement of cells, connectors and terminals to form a battery.

**Automotive Battery** SLI battery of 3 or 6 cells used for starting, lighting and ignition of cars, trucks, buses, etc.

**Average Voltage** A storage battery's average value of voltage during a period of charge or discharge.

**Battery (Storage)** A connected group of two or more storage cells.

Common usage applies this term to a single cell used independently.

**Bridge** The ribbed supporting structure in the bottom of a battery container that provides sediment space under the elements, thereby preventing short circuits.

**Burning** Welding together two or more lead or lead alloy parts such as plates, straps, connectors.

**Burning Center** The center-to-center distance between adjacent plates of the same polarity.

**Burning Stick** A lead or lead alloy stick used as a supply of joining material in lead burning.

**Cadmium** A metallic element highly resistant to corrosion, used as a protective plating on certain parts and fittings.

**Cadmium Electrode** A third electrode for separate measurements of the electrode potential of positive and negative plate groups.

**Calcium Lead Alloy** A lead base alloy that is sometimes used for battery parts in place of antimonial lead alloys.

**Capacity** See **Ampere Hour Capacity**.

**Capacity Test** A test that discharges the battery at constant current at room temperature to a cutoff voltage of usually 1.75 volts/cell.

**Cast** Forming a molten substance into a shape by introducing the material into a mold and allowing it to solidify.

**Casting** A metallic item, such as one or more grids, straps or connectors, formed by pouring a molten substance into a mold and allowing it to solidify.

**Cast-On Strap** A multiple connector that had been cast onto the plates directly in a combination mold/burning jig; contrasts with burning of plates and prefabricated straps.

**Cathode** An electrode through which current leaves any non-metallic conductor. Specifically, an electrolytic cathode is an electrode at which positive ions are discharged, or negative ions are formed, or at which other reducing actions occur.

**Cell (Primary)** A cell designed to produce electric current through an electrochemical reaction that is not efficiently reversible and hence the cell, when discharged, cannot be efficiently recharged by an electric current.

**Cell (Storage)** An electrolytic cell for generation of electric energy, in which the cell after discharge may be restored to a charged condition by an electric current flowing in a direction opposite to the flow of current when the cell discharges.

**Charged** A storage cell at maximum ability to deliver current. The positive plates contain a maximum of lead oxide and a minimum of lead sulfate, and the negative plates contain a maximum of sponge lead and a minimum of sulfate, and the electrolyte is at maximum specific gravity.

**Charged and Dry** A battery assembled with dry, charged plates and no electrolyte.

**Charged and Wet** A fully-charged battery containing electrolyte and ready to deliver current.

**Charging** The process of converting electrical energy to stored chemical energy. In the lead acid battery, it converts lead sulfate in the plates to lead peroxide (positive) or lead (negative).

**Charging Rate** The current, expressed in amperes, at which a battery is charged.

**Circuit** A system of electrical components through which an electric current is intended to flow. The continuous path of an electric current.

**Cold Crank Test** A test that applies a high rate of discharge to a battery at 0°F, and the 30 second cell voltage must be above 7.2v.

**Constant Current Charge** A charge that maintains the current at a constant value. For some types of batteries this may involve two rates, called a starting and a finishing rate.

**Constant Potential Charge or Constant Voltage Charge** A charge that holds the voltage at the terminals at a constant value.

**Container** Housing for one or more cells, commonly called a "jar."

**Cover** The lid of an enclosed cell, generally made of the same material as the container and through which the posts and vent plug extend.

**Cover Inserts** Lead or lead alloy rings molded or sealed into the cell cover, and that the element posts are burned to, thereby creating an effective acid creep-resistant seal.

**Creepage** Travel of electrolyte up the surface of electrodes or other parts of the cell above the level of the main body of the electrolyte.

**Curing** Chemical conversion process that changes lead oxides and sulfuric acid to mixtures of basic lead sulfates, basic lead carbonates, etc., which consequently forms the desired structures of lead or lead sulfate on negative and positive plates during formation.

**Current** The time rate of flow of electricity, normally expressed as amperes, like the flow of a stream of water.

**Cut-Off Voltage** See **Final Voltage**.

**Cutting (of acid)** Dilution of solution of sulfuric acid to a lower concentration.

**Cycle** A discharge and its subsequent recharge.

**Cycle Service** Battery operation that continuously subjects a battery to successive cycles of charge and discharge, e.g., motive power service.

**Deep Discharge** Removal of up to 80% of the rated capacity of a cell or battery.

**Dielectric Test** An electric test performed on jars, containers and other insulating materials to determine their dielectric breakdown strength.

**Diffusion** The intermingling or distribution of particles or molecules of a liquid.

**Direct Current** A one-direction current. Abbreviated *DC*.

**Discharge** Conversion of a battery's chemical energy into electrical energy.

**Discharged** A storage cell when, as a result of delivering current, the plates are sulfated, the electrolyte is exhausted, and there is little or no potential difference between the terminals.

**Discharge Rate** Any specified amperage rate at which a battery is discharged.

**Dry Charged** Battery plates that have been subjected to the dry charging process.

**Dry Charging** Manufacturing process in which tank-formed battery plates are washed free of acid and then dried.

**Efficiency** The ratio of the output of a cell or battery to the input required to restore the initial state of charge under specified conditions of temperature, current rate and final voltage.

**Electrode** A conductor through which current passes in or out of a cell.

**Electrode (Electrolyte) Potential** The difference in potential between the electrode and the immediately adjacent electrolyte, expressed in terms of some standard electrode potential difference.

**Electrolysis** Electrochemical reaction that causes the decomposition of a compound.

**Electrolyte** Any substance that dissociates into two or more ions when dissolved in water. Solutions of electrolyte conduct electricity and are decomposed by it. For batteries, electrolyte implies a dilute solution of sulfuric acid.

**Electromotive Force (EMF)** Electrical pressure or potential, expressed in volts.

**Element** An assembly of a positive plate group, negative plate group and separators.

**End Gravity** The specific gravity of a cell at the end of a prescribed discharge.

**Energy Density** Ratio of battery energy content in watt hours to battery weight in volume.

**Envelope** A separator folded and wrapped around a battery plate during assembly.

**Equalizing Charge** An extended charge given to a storage battery to ensure complete restoration of active materials in all the plates of the cells.

**Expander** An ingredient in the negative paste that delays shrinking and solidifying of the sponge lead of the finished plate, thereby enhancing negative plate capacity.

**Ferroresonant Charger** A constant volt power supply containing a special transformer-capacitor combination that changes operating characteristics as the draw is varied, ensuring that voltage output remains constant.

**Filling Gravity** The specific gravity of acid used to fill batteries.

**Final Voltage** The cut-off voltage of a battery. The prescribed voltage reached when the discharge is considered complete.

**Finishing Rate** The rate of charge, in amperes, to which charging current is reduced near the end of the charge for some types of batteries to prevent gassing and temperature rise.

**Fixed Resistance Discharge** Discharge of a cell or battery through a fixed resistive load, the current being allowed to fall off as the terminal voltage decreases.

**Float Plate** A pasted plate.

**Float Charging** A recharge at a very low rate, accomplished by connection to a buss whose voltage is slightly higher than the open circuit voltage of the battery.

**Foot** Projections from the grid at the bottom edge, used to support the plate group.

**Formation or Forming Charge** An initial charging process that electrochemically converts the raw paste of the plates into charged active material,

lead peroxide in the positive plates and sponge lead in the negative plates.

**Formed** Plates that have undergone formation.

**Freshening Charge** A charge given batteries in storage to replace the standing loss and ensure that every plate is periodically brought up to full charge.

**Full Charge Gravity** Specific gravity of the electrolyte when cells are fully charged and properly leveled.

**Gang Vent** Vents for usually six adjacent cells that are connected to a common manifold.

**Gassing** Bubbles from gases being released at one or more of the electrodes during electrolysis.

**Glass Mat** Fabric made from glass fibers with a polymeric binder such as styrene or acrylic which is used to help retain positive active material.

**Gravity** Specific gravity.

**Gravity Drop** The number of points reduction or drop of specific gravity of the electrolyte from cell discharge.

**Grid** A metallic framework used in a battery for conducting electric current and supporting the active material.

**Group** One or more plates of one type – positive or negative – burned to a post or strap.

**H<sub>2</sub>SO<sub>4</sub>** Sulfuric Acid.

**High Rate** On charge, any rate higher than the normal finishing rate.

**Hydration (Lead)** Reaction between water and lead or lead compounds. Gravities lower than those found in discharged cells are apt to produce hydration, which appears as a white coating on plate groups and separators in a cell.

**Hydrometer** A device used to measure density or specific gravity of electrolyte solutions.

**Hydroset** Curing process for plates that oxidizes the lead paste, reducing free lead to a few percent of total.

**Initial Voltage** The closed circuit voltage at the beginning of a discharge. It is usually measured after current has flowed for a period sufficient for the voltage rate of change to become practically constant.

**Insert** A bushing of lead or lead alloy molded or sealed into cell covers, and to which the post is burned to create a creep-resistant, cover-to-post seal.

**Intercell Connector** Conductor of lead or lead alloy used to connect two battery cells.

**Internal Resistance** Resistance within a cell or battery to the flow of electric current, measured by the ratio of the change in voltage to a specified change in current for a short period of time.

**Jar** Housing, or container, for one or more cells.

**Jar Formation** Forming of plates in the cell jar.

**Jumper** A short length of conductor used to connect or cut out part of an electrical circuit.

**Kilovolt** One thousand volts.

**Kilowatt** One thousand watts.

**Kilowatt Hours** A measure of energy or work accomplished, being 1000 watt hours.

**Lead (Pb)** Chemical element used in lead acid batteries.

**Lead Burning** Welding of lead or alloy parts.

**Lead Hydrate** A white lead compound formed by reaction of very dilute electrolyte or water and metallic lead or lead alloys.

**Lead Oxide** A general term for any of the lead oxides used to produce batteries.

**Lead Peroxide** A brown lead oxide which is the positive material in a fully formed positive plate.

**Lead Plated Part** Hardware that has a thin protective layer of lead electrode deposited on the surface.

**Lead Sponge** The chief component of the active material of a fully-charged negative plate.

**Lead Sulfate** A compound that results from the chemical action of sulfuric acid on oxides of lead or on lead metal.

**Level Lines** Horizontal lines molded or painted near tops of battery containers indicating maximum and minimum electrolyte levels.

**Litharge** A yellow-red oxide of lead sometimes used in making active material.

**Local Action** A battery's loss of otherwise usable chemical energy by currents that flow within the cell of a battery regardless of its connection to an external circuit.

**Loss of Charge** Capacity loss in a cell or battery standing on open circuit as a result of local action.

**Lug** A portion of the grid used for support of the plate group, usually a hanging lug on the top edge of the grid. Also, a tab on the grid used for connection of plate to strap and other plates.

**Machine Casting** A fully or semi-automatic grid or small parts casting operation.

**MF (Maintenance Free Battery)** A VRLA sealed absorbed glass mat (AGM) battery.

**Manual Discharge** Capacity test in which the operator disconnects the battery from the test load after all cells have reached the prescribed final voltage. With fixed resistance loads, boost cells are used to keep the discharge rate fairly constant as the test cell voltages drop rapidly near the final voltage. Electronic load manual discharges generally do not require boost cells.

**Microporous Separator** A veneer or grooved-type separator made of any material that has many microscopically small pores.

**Milliampere** One thousandth of an ampere.

**Millivolt** One thousandth of a volt.

**Modified Constant Voltage Charge** A charge in which charging current voltage is held substantially constant while a fixed resistance is inserted in the battery circuit, producing a rising voltage characteristic at the battery terminals as the charge progresses.

**Mold** A cast iron or steel form used to produce a casting of definite shape or outline.

**Mold Coat** A spray applied to metal molds that acts as a release agent and an insulator against rapid heat transfer.

**Moss** Lead crystals that can grow at high current density areas of negative plates— along edges, at feet or at plate lugs— and cause short circuiting.

**Negative Plate** The grid and active material that current flows to from the external circuit when a battery is discharging.

**Negative Terminal** The terminal from which current flows through the external circuit to the positive terminal when the cell discharges.

**OHM** A unit of electrical resistance.

**Oil of Vitriol** Concentrated commercial sulfuric acid, abbreviated OV or O.V.

**Open Circuit** The state of a battery when not connected to either a charging source or a load circuit.

**Open Circuit Voltage** The voltage at a battery terminal when no appreciable current is flowing.

**Oxide (of lead)** A compound of lead and oxygen in one of several proportions used to prepare battery paste.

**Panel** A casting consisting of two or more grids made simultaneously in a single mold.

**Pb** Chemical symbol for lead.

**PbO** Chemical symbol for litharge.

**PbO<sub>2</sub>** Chemical symbol for lead peroxide.

**Pellet** The portion of pasted material contained in a grid section framed by adjacent horizontal and vertical members exclusive of forming bars.

**Peroxide** See **Lead Peroxide**.

**Pig** A cast bar of lead or lead alloy.

**Pig Lead** A grade of highly refined, unalloyed lead.

**Plate** A pasted grid.

**Plate Centers** Distance between center lines of adjoining plates of opposite polarity in a cell. One half the size of a strap center upon which the plates of like polarity are burned.

**Polarization** Change in voltage at terminals when a specified current is flowing; equal to the difference between the actual and the equilibrium (constant open circuit condition) potentials of the plates, exclusive of the internal resistance drop.

**Porosity** The ratio of open spaces or voids in a material to the volume of its mass.

**Positive Plates** The grid and active materials of a storage battery from which current flows to the external circuit when the battery is discharging.

**Positive Terminal** The terminal that current flows toward in the external circuit from the negative terminal.

**Post** Terminal or other conductor that connects the plate group strap to the outside of the cell.

**Pure Lead** Pig Lead.

**Rated Capacity** Ampere hours of discharge that can be removed from a fully charged cell or battery, at a specific constant discharge rate at a specified temperature and at a specified cut-off voltage.

**Rate of Charge** See **Starting Rate** and **Finishing Rate**.

**Raw Plate** An unformed plate.

**Rectifier** A device that converts alternating (ac) current into unidirectional (dc) current because of a characteristic that permits appreciable flow of current in only one direction.

**Red Lead** A red oxide of lead used in making active material.

**Reference Electrode** Electrode used to measure acid concentration or plate state of charge.

**Resistance** The opposition of a conductor to the passage of an electrical current, usually expressed in ohms.

**Resistor** A device used to introduce resistance into an electrical circuit.

**Retainer** A sheet of glass mat, perforated or slotted rubber, plastic or some other material installed on each face of the positive plates in certain types of cells, to deter loss of active material.

**Reversal** A change in the normal polarity of a cell or battery.

**Rib** A vertical or nearly vertical ridge of a grooved separator or spacer.

**Secondary Lead** Reclaimed as opposed to virgin lead.

**Sediment** The sludge or active material shed from plates that drops to the bottom of cells.

**Sediment Space** The portion of a container beneath the element; sediment from the wearing of the plates collects here without short-circuiting.

**Self-discharge** Loss of charge due to local action.

**Separator** A device in a storage battery that prevents metallic contact between plates of opposite polarity in a cell.

**Series Cells** All cells in a battery other than pilot cells. They are so called because the cells are usually connected in series.

**Series Parallel Connection** Cells arranged in a battery so two or more strings of series connected cells, each containing the same number of cells, are connected in parallel; this increases battery capacity.



**Short Circuit Current** The current that flows when the two terminals of a cell or battery are inadvertently connected to each other.

**Side Terminal** SLI battery design with two through-the-container current connections on one side instead of two posts on top.

**SLI Battery** A battery for automotive use in starting, lighting and ignition.

**Sliver, Slyver** Extremely fine parallel glass fibers used in retainers next to positive plates to retard shedding.

**Smelting** The primary process for recovering lead and antimony from scrapped batteries and scrap from battery manufacture.

**Soaking** A manufacturing process following pasting that soaks certain types of lead plates in sulfuric acid. This provides a protective surface and also sulfate helpful in container and tank formation.

**Soda Ash** Sodium Carbonate ( $\text{Na}_2\text{CO}_3$ ) used in neutralizing sulfuric acid in spills or effluents.

**Spalling** Shedding of active material, usually from positives, during formation due to incomplete or improper plate curing.

**Sponge Lead** (Pb) A porous mass of lead crystals and the chief material of a full-charged negative plate.

**Stacking** A cell assembly operation, alternately piling plates and separators in a burning box prior to attachment of straps and posts.

**Standard Battery** Any of Conventional, YuMicron or YuMicron CX batteries consisting of flooded electrolyte and cell accessible construction.

**Standing Loss** Loss of charge by an idle cell or battery, resulting from local action.

**Starting Rate** A beginning charging rate that does not produce gassing or temperatures in excess of 110°F.

**State of Charge** The amount of electrochemical energy left in a cell or battery.

**Strap** Precast or cast-on piece of lead or lead alloy used to connect plates into groups and to connect groups to the post.

**Strap Center** Spacing between centers of adjacent plates in a group.

**Stratification** Layering of high specific gravity electrolyte in lower portions of a cell, where it does not circulate normally and is of no use.

**Sulfated** A plate or cell whose active materials contain an appreciable amount of lead sulfate.

**Sulfation** Formation of lead sulfate on a plate or cell as a result of discharge, self-discharge or pickling.

**Sulfuric Acid** ( $\text{H}_2\text{SO}_4$ ) The principal acid compound of sulfur, sulfuric acid in dilute and highly pure form is the electrolyte of lead acid storage cells.

**Tack Burn** A shallow burn used to tack together two lead parts.

**Tank Formation** Electrolytic processing of plates prior to assembly in large tanks of acid.

**Temperature Correction** In storage cells, specific gravity and charging voltage vary inversely with temperature, while the open circuit voltage varies directly though slightly with temperature.

**Terminals** The points on a battery to which the external circuit is connected.

**Terminal Cable** A length of insulated cable, one end connected to the battery terminal post, and the other fitted with a plug, receptacle, lug or other device for connection to an external circuit.

**Top Pour** A method of casting in which molten metal is poured, usually by hand, into a top gated mold.

**Treeing** Growth of a lead dendrite or filament through a crack or hole of a separator, short-circuiting the cell.

**Trickle Charge** A low-rate continuous charge approximately equal to a battery's internal losses and capable of maintaining the battery in a fully-charged state.

**TVR** A temperature compensating voltage relay used in charging equipment.

**Unformed** A plate that has not been electrolytically formed.

**Useful Acid** The acid above the lower edges of the plates that takes part in the discharge reactions that occur within a cell.

**Vent** An opening that permits the escape of gas from a cell or mold.

**Vent Plug** The seal for the vent and filling well of a cell cover, containing a small hole for escape of gas.

**Vent Well** The hole or holes in a cell cover that allow fluids to be checked, electrolyte to be added, and gas to escape. The vent plug fits into the vent well.

**Verticals** The members in a plate grid.

**Volt** The unit of measurement of electromotive force, being the force needed to send a current of one ampere through a conductor with a resistance of one ohm.



**Volt Efficiency** The ratio of the average voltage of a cell or battery during discharge to the average voltage during subsequent recharge.

**Voltage** The difference in electrical potential that exists between the terminals of a cell or battery or any two points of an electrical circuit.

**Voltage Range** The difference between maximum and minimum cell voltages within a battery or string of cells when all cells are charging and discharging.

**Voltmeter** An instrument for measuring voltage.

**VRLA (Valve Regulated Lead Acid)** Sealed batteries which feature a safety valve venting system designed to release excessive internal pressure, while maintaining sufficient pressure for recombination of oxygen and hydrogen into water.

**Watering** Adding water to battery electrolyte to replace loss from electrolysis and evaporation.

**Watt** A unit of electric power, equal to a current of one ampere under one volt of pressure.

**Watt-hour** A unit of electrical energy or work, equal to one watt acting for one hour.

**Watt-hour Capacity** The number of watt-hours a storage battery can deliver under specific conditions of temperature, rate of discharge and final voltage.

**Watt-hour Efficiency** A storage battery's energy efficiency expressed as ratio of watt-hour output to the watt-hours of the recharge.

**Watt-hour Meter** An electric meter that measures and registers electrical energy in watt-hours.

**Wet Shelf Life** The time a wet secondary cell can be stored before its capacity falls to the point that the cell cannot be easily recharged.

# YUASA® BATTERY ACCESSORIES



## Jumper Cables

Part No. YUA00ACC07

- Easy to use, easy to store
- Convenient storage bag
- Heavy duty, 8 ft., 8-gauge cables won't stiffen or freeze
- Tangle resistant, encased rubber grips for safer use



## Battery Tester

Part No. YUA00BTY01

- Developed exclusively for the Powersports industry
- Determines accurate battery status in seconds
- Single load, dynamic resistance technology minimizes battery drain during test
- Tests both charged and discharged batteries accurately
- 1 year limited warranty



## Digital Multimeter

Part No. YUA00ACC05

- Simple to use
- Easy and accurately measures current, voltage and resistance
- Eliminates the guesswork when your battery needs recharging
- A must for checking maintenance free batteries as well as conventional batteries
- 90 day limited warranty



Part No. YUA00ACC02



Part No. YUA00ACC04

## Battery Accessory Lead and Fused Ring Connectors

- Simple, quick connection
- Can be used with Yuasa's 1.5 Amp and 900 mA chargers for applications ranging from motorcycles, automobiles and personal watercraft to ATVs, snowmobiles and riding mowers



## Syringe Hydrometer

Part No. YUAMHYDRO

- Shows exact specific gravity reading on conventional battery's condition

## Battery Analyzer

Part No. YUA00ACC06

- Easy installation
- Shows battery condition at the push of a button
- Offers the confidence of knowing when your battery is fully charged





P.O. Box 14715  
Reading, PA 19612-4715

Telephone: 1-866-431-4784 • Fax: 610-929-1295

[yuasabatteries.com](http://yuasabatteries.com)